

YARIE

Co., Ltd.

**Fishing
Gear
Catalog**

2025

English version



YARIE NAVY FISHING GEAR

YARIE PANTHER



AREA TROUT FISHING GEAR



Y.N.F.G
YARIE
NAVY
FISHING
GEAR

Tonight, we will continue to tell you stories about fishing that will never end.

YARIE NAVY Salt *Zodi* series

SHAHRAZAD

SZ-PG511M *SHAHRAZAD Technical PG*

Rintaro Iwasaki's model for power games fishing to enjoy rockfish fishing.

This rod was developed by Mr. Rintaro Iwasaki, known as a hunter for large black rockfish, to enjoy technical structure fishing from a boat. It is a short rod, but can be used for power game fishing. It is also perfectly suited to catch rockfish such as scorpion fish and grouper and small migratory fish like young giant trevally. It can be very useful for shore fishing and is also attractive for its high versatility.



SHAHRAZAD Technical PG SZ-PG5112M Length: 5'11"
 Recommended lure weight: 1.5-7g
 Recommended line: PE: # 0.2-0.6 FC: 2.5-5 lb Price: ¥42,800 Made in Japan

SZ-BC732L *SHAHRAZAD Technical BC*

SHAHRAZAD's bait casting model is newly released to enjoy fishing at sea. It is an all-round model for every target fish.

It is a regular slow taper that is designed to bend from a tip to a butt lithely so that anglers can take sufficient control of the rod after casting plugs or metal lures ranging from 1/8 to 1/2 oz. Considering action setting thoroughly, an unusual two-piece structure with a little longer tip is adopted for this rod. The rod is equipped with titanium TORZITE guides and the butt section is reinforced and wrapped by quad-axial carbon cloth, which gives better casting accuracy and more lifting power.

SHAHRAZAD Technical BC SZ-BC732L Length: 7'3"
 Recommended lure weight: 3.5-14 g
 Recommended line: PE: # 0.4-0.8 Price: ¥46,800 Made in Japan

■ **No.930** Price: ¥6,000
AQUA MEISTER

High density PE's line which gives you an advantage in fishing (specific gravity: 1.41)
 This high density polyester fiber line offers high sensitivity. It is less likely to be influenced by wind or water flows and has a small elongation, which enables you to feel a slight bite. The special fluorine coating applied on the line surface prevents its wear and enhances its durability. It is best fitted for light salt game such as scad and black rockfish fishing and trout fishing.

PEs line
Twist yarn of polyester fiber
provides cutting-edge absolute sensitivity



#	length	linear strength
0.2	150 m	1.7 kg·3.7 lb
0.3	150 m	1.9 kg·4.2 lb

color : orange
 4 pieces per package
 75-meter marking

1



Y.N.F.G

YARIE NAVY FISHING GEAR



Rintaro Iwasaki



YARIE NAVY Salt Rod series

SHAHRAZAD KR-model Black Edition SZ-632XUL Length 6'3" Line: PE 0.2-0.4 / FC 1.5-3 lb. Lure 0.3-4 g Price: ¥ 44,800 Made in Japan



SHAHRAZAD SZ-632 XUL



"SHAHRAZAD" with delicacy and flexible strength is a rod for anglers who enjoy fishing casually and deeply.

KR model

Further enhancing the sensitivity and power by increasing the number of guides.

Equal quad-axial carbon cloth is adopted for a butt section. The rod offers an ideal bending performance by adopting a strong resilient butt and an extreme thin and delicate tubular top with high sensitivity. We set its length to 6 feet and 3 inches in pursuit of the best possible operability.

A highly versatile model that can be used not only for scad and black rockfish fishing requiring delicate sensitivity, but also for light games such as young giant trevally, barracuda, mackerel, etc. requiring full use of plugs, jigs and spoons with high-speed actions.

- The butt adopting quad-axial carbon cloth is strong enough to manage an unexpected large fish.
- Enables comfortable casting by minimizing oscillations of the butt and improves casting ability of a light lure.
- Adopts cutting-edge "TORZITE" guide rings and creates a well-balanced rod.
- Provides super high sensitivity thanks to the micro guides.
- Has an easy-to-grip handle design to fit into the palm which enables anglers to successfully and instantly hook a fish snapping at a bait.



Lansa evolution NOIR

SiC-S
titanium

Lansa evolution NOIR LN-6102L

Length : 6'1" / Lure : 0.5~4.5g Line : PE 0.2~0.4 ES 0.25~0.5
4-Axis Carbon

This rod is designed primarily for release fishing and angling in wide areas.

The rod has a medium-light stiffness, ensuring that fish never gain the upper hand. However, to minimize missed bites from fast-striking stocked fish, it is crafted with a perfect balance—firm yet flexible.

Thanks to its powerful and resilient design, it handles bottom-knocking with long-lip crankbaits effortlessly.

The rod is equipped with seven guides, intentionally chosen to reduce friction during casting. This minimizes lure deceleration and allows the lure to travel further than usual, even reaching previously unreachable areas.

The grip is shortened to prevent it from hitting your body during jerking motions, enabling precise lure control.

Compatible with various types of fishing lines, this rod offers anglers limitless possibilities for their fishing style.

Lansa evolution NOIR LN-6102L

Lansa evolution NOIR LN-6102L

Length : 6'1" / Lure : 0.5~4.5g Line : PE 0.2~0.4 ES 0.25~0.5 made in Japan ¥48,000



4-Axis Carbon

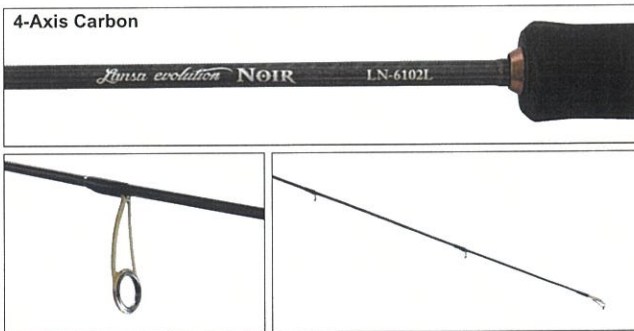

sensitivity

All guides are made of Fuji Industrial's SiC-S. The design allows you to sense even the subtle changes characteristic of light game fishing.

spigot joint



Design & Parts

The design allows you to sense even the subtle changes characteristic of light game fishing.



YARIE PANTHER
AREA TROUT FISHING GEAR

Lansa Giulietta BORON
LG-5112UL+

Delicate sensitivity that captures even the slightest changes, combined with exceptional casting performance for lightweight lures to reach even greater distances.

Lansa Giulietta **BORON**
LG-5112UL+

Lansa Giulietta BORON LG-5112UL+
Length : 5'11" / Lure : 0.4~3.5g Line : PE 0.2~0.4 FC 1.5~3lb ¥54,000



LG-5112UL+

Lansa Giulietta BORON



Lancer Giulietta is a power-up model that inherits the essence of the base model, Lancer Distantia, while significantly improving casting distance for micro spoons and micro plugs. By using boron in the butt section, the rod maintains its original design, providing both exceptional resilience and high sensitivity with a firm, crisp feel. Additionally, enhancements to the custom parts in the rod joint section contribute to increased casting distance and improved lure control.

The Lancer series features a medium-fast taper, designed to reduce the chances of losing hooked fish. The rod retains its soft tip-to-belly section, allowing fish to bite and hook naturally. With the latest customizations and enhancements, anglers can now take a more active role in setting the hook.

The carefully crafted guide setting, a signature of the series, also remains intact. Moreover, the rod now offers compatibility with finer ester lines, further boosting sensitivity performance. While preserving the distinct characteristics of the base model, Lancer Distantia, this new rod is designed to meet and exceed the expectations of anglers.

sensitivity



Fuji "TORZITE" rings are used for all guides of Lansa Distantia, which offers high sensitivity of detecting delicate movements specific to light games.



Design & Parts



The design of the rod shows that Mr. Tanaka's particular attention was paid to every part. This rod is equipped with the custom-made cork short grip and high-quality design is pursued in all details of the rod.

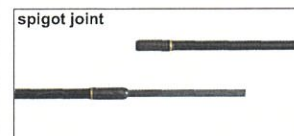

spigot joint

Lansa Distancia BORON EVA

LD-5112UL Length: 5'11" Line: PE 0.2-0.4 / FC 1.5-3 lb Lure: 0.3-3 g
Price: ¥ 53,500 joined with inrotsugi Made in Japan

Mr. Hideki Tanaka, a top contestant in fishing tournaments **aims at long casting distance and better sensitivity.**

Making choice of BORON

By using BORON in the butt part, Lansa Distancia is designed to be a high-sensitivity rod with strong tenacity and tension. Combined with a high-sensitivity material, ester line, this rod enables you to detect even softest bites that you never have detected before. Casting by flicking the upper soft part of the rod from the belly to the tip when using a light lure enables surprisingly long casting distances. When using a heavier lure, using repulsive force of BORON in the butt part with a lure weight on the blank during the cast allows the same long casts.

Once hooked, never let fish get away.

This is a medium fast tapered rod with the relatively soft tip and belly sections. It is designed to enable easy penetration and instant hooking when detecting a bite.

Specially selected guide setting

By increasing the number of guides to eight and decentralizing the load on the line, Lansa Distancia can use a one-rank thinner line that is resistant to side winds.

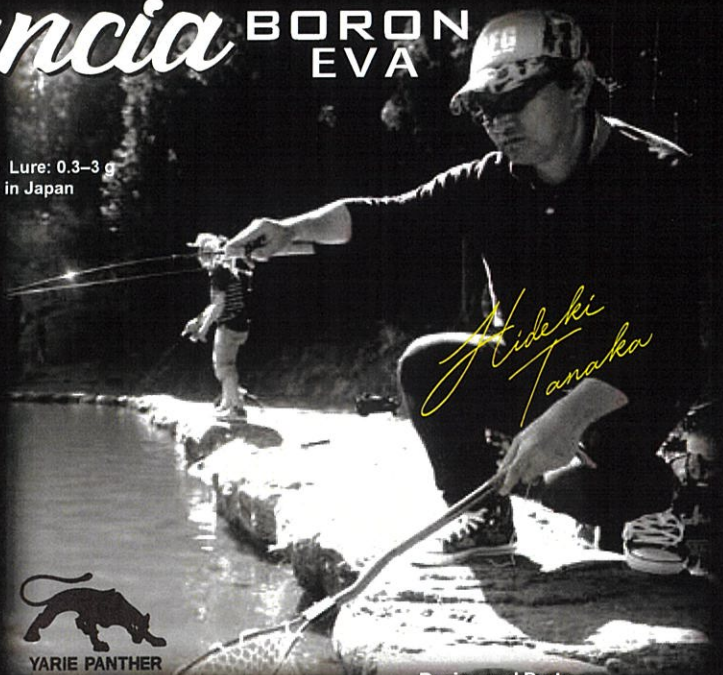

Design and Parts

The design of the rod shows that Mr. Tanaka's particular attention was paid to every part. This rod is equipped with the custom-made cork short grip and high-quality design is pursued in all details of the rod.

Sensitivity

Fuji "TORZITE" rings are used for all guides of Lansa Distancia, which offers high sensitivity of detecting delicate movements specific to light games.



spigot joint

5

Folgore

FG-623UL Length: 6'2" Line: PE 0.2-0.4 / FC 1.5-3 lb Lure: 0.3-5 g
Price: ¥ 37,800 joined with inrotsugi

High mobility which enables you to carry the rod anywhere you like 3-piece rod for all light gamers.

3 piece

The bent and curved form which takes advantage of the properties of the 3-piece rod creates a "torqueful and ideal arc."

Folgore enables you to cast a lure far out into the water; to secure bites in a firm hooking; and to pull hooked fish closer to catch without losing control of the rod.

"Folgore" is a rod which pursues elements required for light games. This rod provides utility which is demonstrated for any fish species (fishing target) and mobility at any location (fishing point). Folgore will offer you a new dimension of light games.

Mobility

The rod with a 3-piece rod design gives good mobility and its total storage length is 70 cm (approx. 27.5 inches). This rod has excellent mobility which any 2-piece rod does not have. Folgore's unique bending curve created by the 3-piece rod design can be adjusted for any fish species (fishing target) and will allow you to explore a new world of light games.

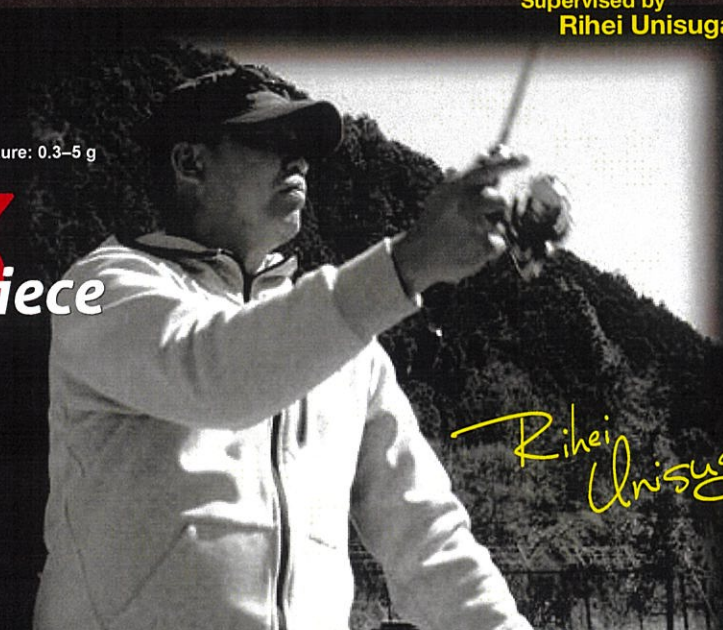

Supervised by **Rihei Unisuga**

Sensitivity

Fuji "TORZITE" rings are used for all guides of Lansa Distancia, which offers high sensitivity of detecting delicate movements specific to light games.



Design and Parts

This rod is designed to emphasize functionality, paying attention to joints. Users can enjoy its simple and chic design which they will never get tired of. It is manufactured for long-term usage.



spigot joint

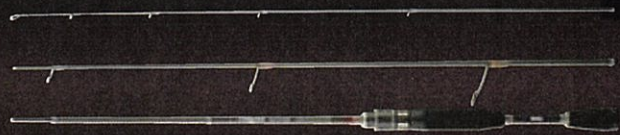

A jig head exclusively for power game fishing

This hook using high carbon steel is perfectly suited to power game fishing.

They are a jig head and a jig hook for power game fishing primarily for large rockfish and giant scad. These are our fastidious jig head and jig hook with their hook points bending outward to ensure good hooking and with shape which can be easily swallowed by fish. Their wire diameters are selected to fight with large and giant fish. The jig head and hook are developed in pursuit of the best possible catch of your target fish in strong currents.

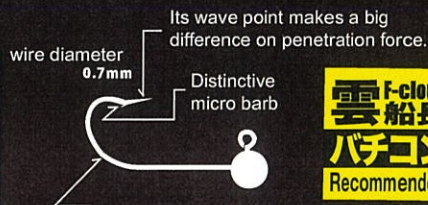

This hook using high carbon steel is perfectly suited to power game fishing.

Available for vertical contact, reverse drop shot rig, and Carolina rig

No.567 Ajimebagachi JH-ND

The hook specification exclusively for power battle fishing ensures the strength which will sufficiently withstand powerful bites of giant scad. A soft bead is mounted at the head of the hook to produce a movement of a naturally drifting worm.



hook: #6 6 pieces ¥350

No.637 Ajimebagachi JH non-painted
Hook black 0.4g, 0.7g, 1.0g 5pieces ¥350
Hook gold 0.4g, 0.7g 4pieces ¥350



hook: #6 0.4g, 0.7g, 1.0g

No.639 Ajimebagachi JH non-painted



hook: #4 1.8g, 2.5g, 3.2g 5 pieces ¥350

No.638 Ajimebagachi hook

Adjust weight by attaching a commercially available Gandama sinker to the hook.

wire diameter 0.7mm



hook: #6 gold 7 pieces ¥300
black 9 pieces ¥300

CHINUBAL No.687 CHINUBAL 8 pieces ¥540

Length: 2 inches (about 5 cm)

When cut at the cut position, it will be 8 mm shorter.

Features: Its big claws and round pretty eyes entice fish. Its legs shake to attract fish.



2 inches

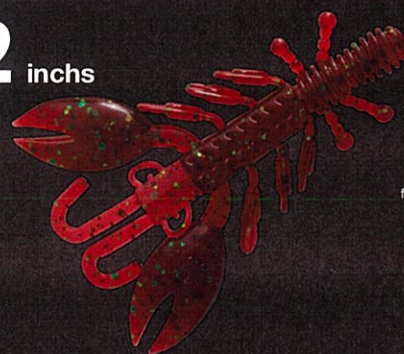

This is a crawfish-like lure aimed at black sea bream and rock fish.

A combination of strong wave motion created by its big chelae and minute and complicated movements produced by its legs strongly appeal to fish. It is made from soft material which doesn't make fish cautious. CHINUBAL mixed with fluorescent violet and fish gathering component appeals to the sense of smell and eye to entice fish to bite.



Aji Baku アジ爆 JIG HEAD

A unique shape of a hook point which goes outward slightl allows you to instantly hook scad when you feel its slight bite. The jig head is painted red which entices scad to bite.

Actions are transmitted to the point using the principle of leverage by having the eye angled downward at 20 degrees toward the hook point. It increases your hook-up rate.

Its ultra-micro barb penetrates a fish's hard jaw easily.

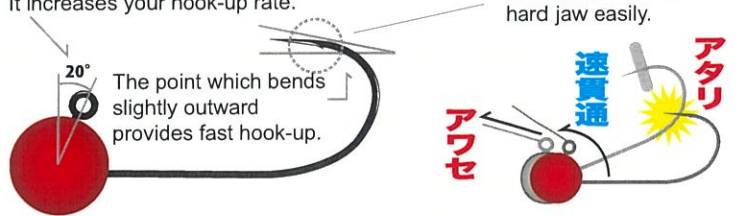

No.635 Ajimeba rider JH red-painted

It is a swimming jig head which provides high range keeping performance. It shakes in small motions at the time of a curve fall as if it were a live worm. Its keel-shaped head enables it to swim through obstacles without being caught by rocks, fishing banks, etc. Its hook for fast penetration enables capture of fish which bites a hook.

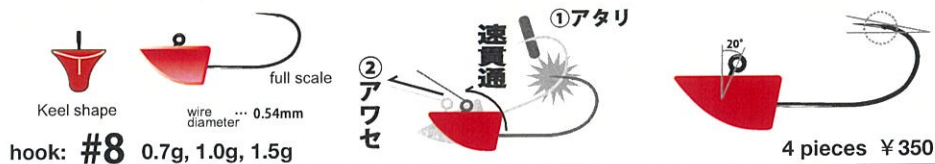

No.645

Ajibaku JH red-painted

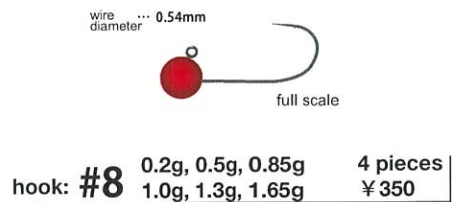

No.634

Ajimeba rider JH non-painted

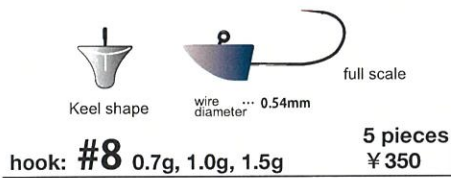

No.656 Hayagake jighook

The unique shape of a hook point which goes outward slightly allows you to instantly hook scad and black rockfish when you feel their slight bite.

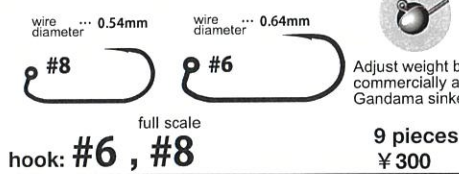

No.646

Ajibaku JH red-painted

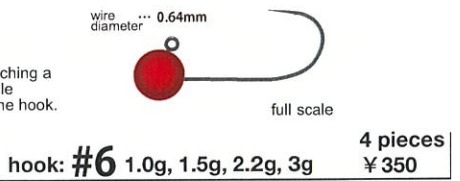

7



Mebary 速掛け

Catches a black rockfish which short-bites your bait in one stroke! Ultra-micro barb focusing on hooking fish. Outward hook point providing fast hook-up.

No.619

Mebary hayagake JH non-painted

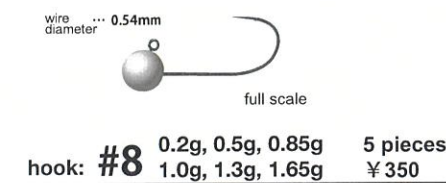

No.616

Mebary hayagake JH non-painted

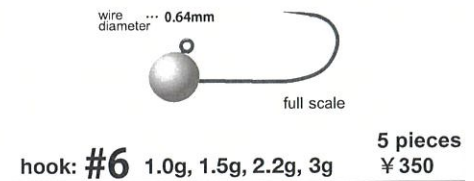

No.617

Mebary barbless JH non-painted

Ultra-mini-sized jig head which is designed to be more compact and smaller.



アミパターンだからってあきらめていませんか？

When a fishing spot has an abundance of opossum shrimps and fish only eat them and satisfied, are you giving up catching fish at the spot?

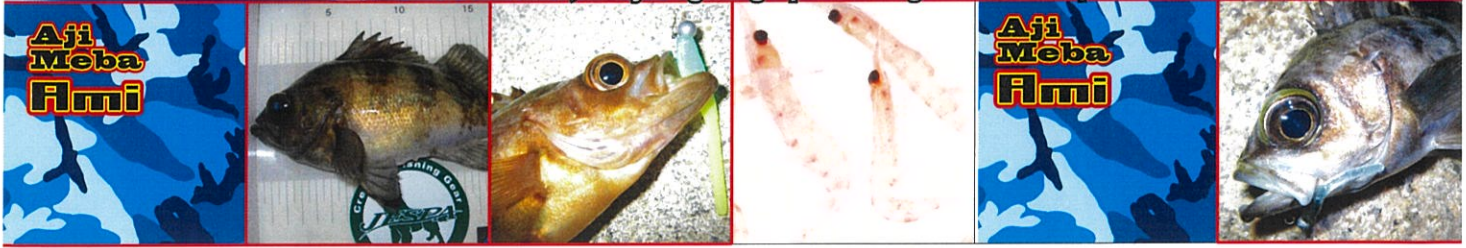

No.647 Ajimeba ami JH non-painted

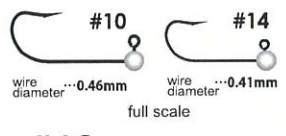

hook: **#10** 0.2g, 0.4g, 0.6g
hook: **#14** 0.2g, 0.4g, 0.6g
5 pieces ¥350

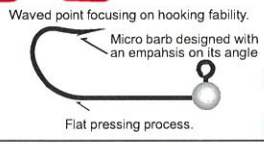

No.648 Ajimeba ami hook

Setting of the hook size exclusively for the case where a fishing spot has an abundance of opossum shrimps and fish only eat them and satisfied.

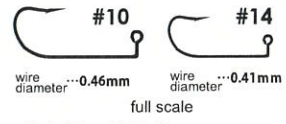

hook: **#10, #14**
9 pieces ¥300

Adjust weight by attaching a commercially available Gandama sinker to the hook.



JIG HEAD No.615 Minimini JH neo keeper

A model equipped with Neo Keeper which prevents a worm head from cracking and slipping off the hook.

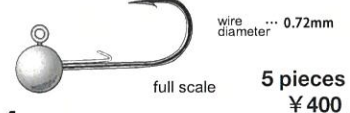

hook: **#4** 1.0g, 1.5g, 2.0g, 2.5g, 3.5g
5 pieces ¥400

No.526 Clip snap

The setting is completed by passing the hook eye of a lure through the gap between wires and shifting it down to the bottom of the wire.



SIZE	Max LB	Max KG	wire (mm) diameter	total (mm) length
M	6.5	3.0	0.5	8.0
SS	3.8	1.7	0.4	6.3



No.652 Mini jig hook sode

Adjust weight by attaching a commercially available Gandama sinker to the hook.

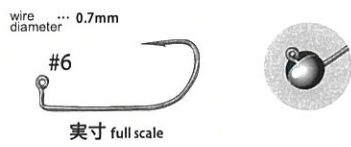

hook: **#6**
9 pieces ¥300

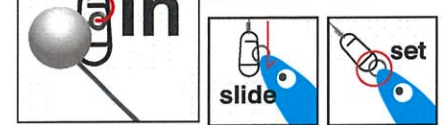
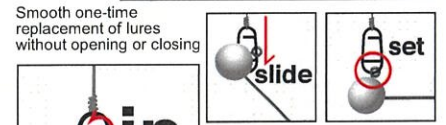

7 pieces ¥250



No.528 Ajimeba snap

Easy to change jig heads, etc. quickly. Thin stem wire which is easily inserted into the eye of the jig head.

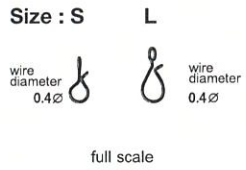

Size : S, L 5LB
7 pieces ¥300

No.527 Rolling swivel with Ajimeba snap

Easy to change jig heads, etc. quickly. Thin stem wire which is easily inserted into the eye of the jig head.

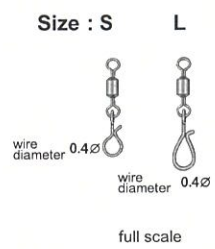

Size : S, L 5LB
4 pieces ¥300

No.664 Micro guide threader

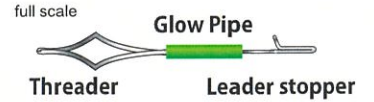

■Eye threader ■Guide threader

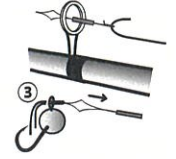
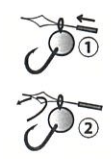

(1) Insert the tip of "Eye Threader" in the hole of a hook.
(2) Pass the line through the ring of "Eye Threader."
(3) Pull "Eye Threader" through the hole of a hook, then the line will pass through the hole.

2 pieces ¥200



Aji Baku アジ爆 WORM



AJI-BAKU worm is developed exclusively for scad, mixing with fluorescent violet. It works well under light source such as sunlight, moonlight, electric light, etc. Perfectly suited to AJI-BAKU jig head.

Perfectly suited to AJI-BAKU jig head !

1.8 inches No.690 Ajibaku worm 1.8 inches

Shrimp Scent Ultraviolet light-emitting, Luminous color 8 pieces ¥360



Ultraviolet light emitting : 12P, 26P, 41P, 46P, 47P, 48P



Luminous color : 71L



Luminous color : 34L

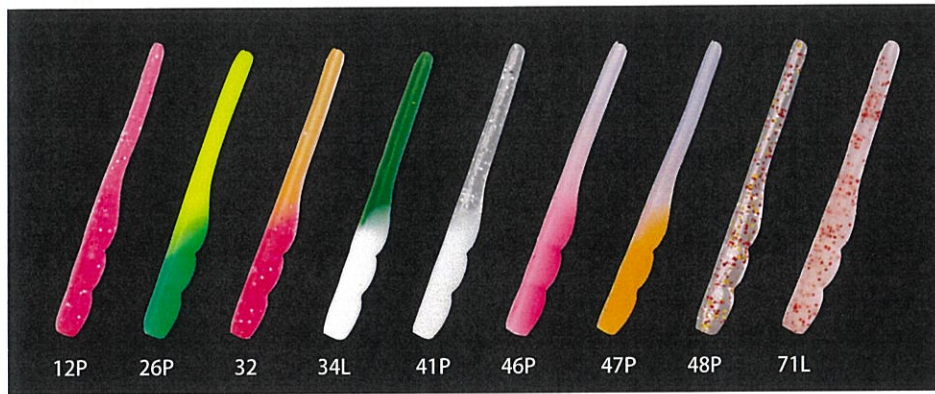

Cut position



0.3 inches 0.3 inches 0.3 inches

Please cut the worm at cutting points spaced every 0.3 inches on the head part and adjust it to the size of your bait.

9

2.8 inches No.690 Ajibaku worm 2.8 inches

Super Soft Material

The slender long body appeals to scad strongly. A soft material is used in the worm to allow scad to easily swallow the worm even when they bite it slightly. The soft material will not provide a feeling of strangeness to scad.

The worm has cut positions to be cut to suit the size of a bait you use. Please aim for more successful fishing by using the worm in combination with "Keime Light," luminescence or fluorescence.



Ultraviolet light emitting : 26P, 41P, 44P, 47P, 48P



Luminous color : 34L



Luminous color : 35L, 71L



Cut position



Shrimp Scent Ultraviolet light-emitting, Luminous color 8 pieces ¥540



アミパターンだからってあきらめていませんか？

When a fishing spot has an abundance of opossum shrimps and fish only eat them and satisfied, are you giving up catching fish at the spot?

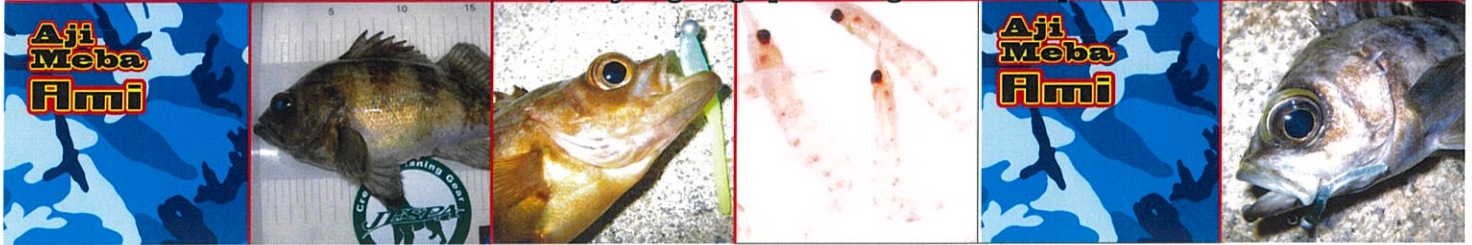

No.691 Amibaits 0.9 inches
14 pieces ¥400

Shrimp Scent



It is an ultra-small silhouetted worm dedicated to a bothering situation for anglers where a fishing spot has an abundance of opossum shrimps and fish only eat them and satisfied. Its body with ribs and pointed tail creates slight wave motion which stimulates the appetite of target fish such as scad and black rockfish and entices them to bite. It is recommended to use a dedicated jig head, "Aji Meba Ami" which perfectly fit this worm.

Perfectly suited to Aji Meba Ami jig head !

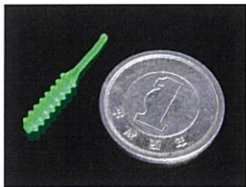

Ultraviolet light emitting: 12F-52F
Luminous color : 71F

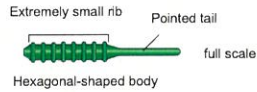

10

2 inches No.690 Ajibaku worm 2 inches

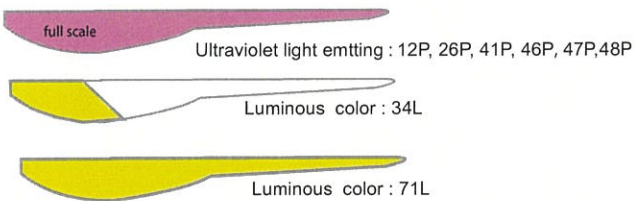

Shrimp Scent Ultraviolet light-emitting, Luminous color 7 pieces ¥360

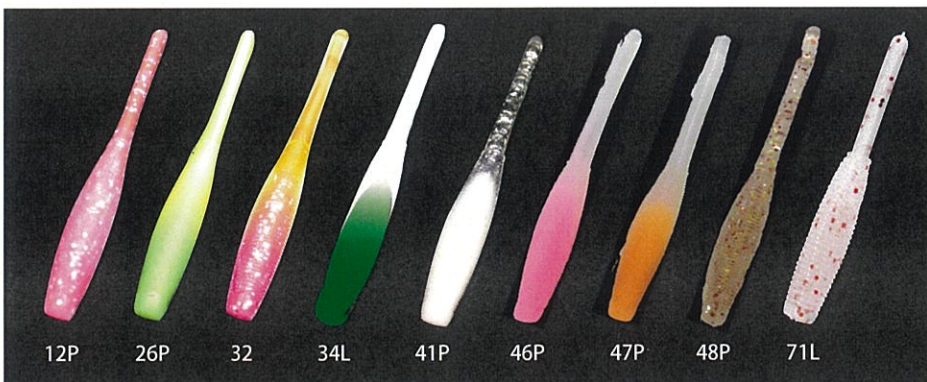



PLOVER

Treble hook #10
No.665 PLOVER ¥550
4g



Providing quick action on start-up!

Well adapted to high speed retrieving!
 Slender willow leaf spoon adapted to high-speed bites of young giant trevally and barracuda. As the spoon is designed to be asymmetric and features quick swimming action as soon as landing in the water after casting, you can surely retrieve the spoon in the target range. Suppressing wobbling by reducing the water resistance against the spoon, it is adopted to ultra-fast retrieving. By varying retrieves with twitches and jerks, it rouses the baiting instinct of fish and to entice fish to bite.

silver base



H:40mm
 W:10mm



Hologram-color ¥550

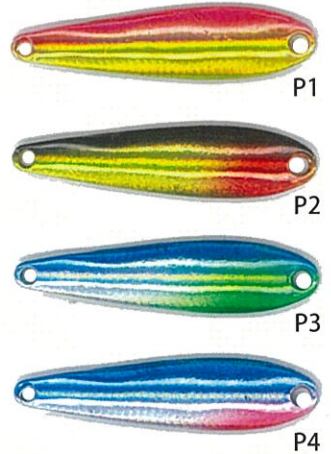

11

gold base



Swivel designed for hairtail jiggling with excellent durability.



No.561 Tachizo swivel
 30LB



3 pieces
 ¥300

No.644 Tachiuo tenya JH

It is a tenya-shaped jig head for hairtail, designed for short casting. The upside-down hook is significantly effective for hairtail which is hooked and swims vertically upward. It includes Neo Keeper which makes it easy to pierce a worm and keeps the worm from slipping off the hook. When you fail to catch hairtail, change from a worm to a live bait. As it is designed for a short casting, it can be used with a lure rod such as a bass rod.



1-2.0g
 # 1/0-3.5g

4 pieces
 ¥300



No.599 Mame jig

Silicone Rubber Jig

Target
Black Bass
Pike
Zander
Parch

Introducing our Silicone Rubber Jig, expertly designed for a delicate approach, capable of mimicking bait like crayfish, shrimp, and insects. Its size advantage makes it a standout performer even in high-pressure fishing situations. We've chosen a round jig head with an emphasis on maneuverability, complete with a small keeper to protect your worm. Customize your experience by cutting the rubber to your preference and enjoy a variety of fishing patterns.

color: 001-orange chart

002-brown

003-chart

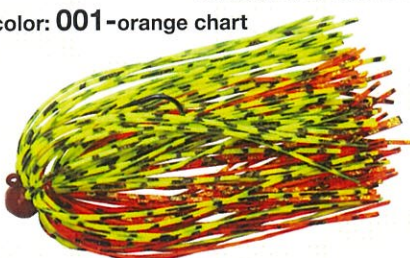

1 piece
 ¥600

hook: #1-1.0g, 1.5g 2.0g, 3.5g, #1/0-1.0g, 1.5g 2.0g, 3.5g, #2/0- 1.0g, 1.5g 2.0g, 3.5g

GREBE

No.667
GREBE
20g ¥900



GREBE, a spoon for saltwater fishing is a versatile lure which can be used for fishing from the surface to the bottom. This spoon works well with fast retrieve, by skipping and splashing it on the surface to entice bluebacks to bite.

After the lure lands on the water surface and you count down the right amount of time needed for the lure to reach the target zone, an angled head receives resistance from water upon the straight retrieve producing action imitating a weakened fish.

GREBE is effective for sea bass fishing on sand beach and flatfish fishing. Please use GREBE freely as you want.



Target fish range from migrant fish such as yellowtail, mackerel, and hairtail, to seabass, flounder (for fishing from a sand beach), and flathead. As the weight of a GREBE is 20 g, it is suitable for light-to-medium casting rods and rods squid fishing (eging in Japanese).

When you aim at yellowtail and young great amberjack which are responsive at top water, cast a line as far as possible. After the lure lands on the surface, raise the rod and retrieve the line with light twitch to get the lure splashing water side to side while reflecting light on the curved surface of GREBE and producing glittering effect, which looks like fish trying to get away in the water. It will lead to an exciting catch on the top water.

Basic-color ¥900



Hologram-color ¥950

GREBE with mackerel-like pattern on hologram background (5 colors)

More appealing lure increases your catch!

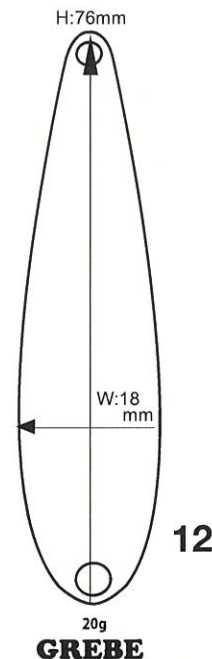
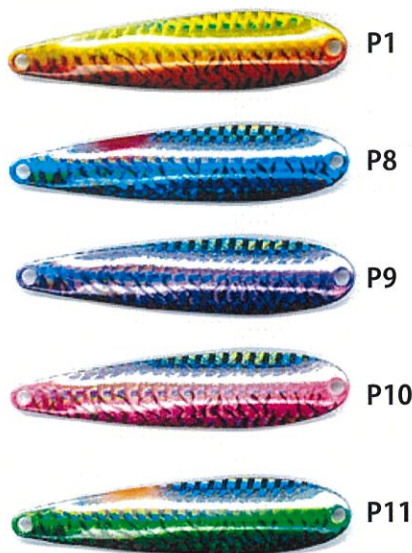

No.122 Guruguru joint

size: S

Two parts rotate smoothly to prevent line twists. Hook type joint makes it easy and speedy to change fishing tackles. Recommended nylon line: 3lb-8lb. Before using this joint, check if the line is tied tightly. Make a tied knot to tie the line firmly.



6 pieces
¥300

No.405 Round JH VF

Fine wire
Ø0.85mm

Straight point jig focusing on penetration
Fine wire

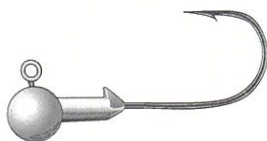

Value Pack

hook: #1/0 2.0g, 3.5g, 5g, 7g

10 pieces
¥550

No.406 Round JH VS

Standard wire
Ø0.9mm

Curved point designed with semi-barb
Standard wire

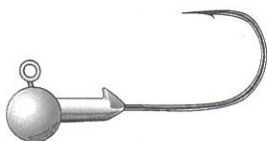

Value Pack

hook: #1/0 2.0g, 3.5g, 5g, 7g

10 pieces
¥550

No.407 Round JH VT

Thick wire
Ø1.07mm

Short shank and wide gape
Thick wire with thick shaft

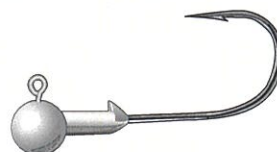

Value Pack

hook: #3/0 2.0g, 3.5g, 5g, 7g

10 pieces
¥550

山木一人監修

BASS



Boil sniper
Look for a spot where fish is boiling on the surface and make a long cast with the boil sniper.

- Features
- Easy to cast far
 - Not easy to float up or sink
 - Able to keep in your target range
 - Able to pinpoint a rise

Two single hooks attached facing each other to the lure
Two single hooks are attached facing each other to the lure to improve hooking when making a fall and to reduce problems such as getting snagged.

can the QR code to see an instructional video on Bass Spoon



13



GREBE

Boil Sniper



No.667 GREBE BASS Lineup: 20g -76mm ¥950

Boil Sniper has a slender shape and excellent flying distance. It can reach distant points and spots where fish are boiling offshore that you have given up until now. It mainly makes rolling actions. It is designed to prevent from floating up, thereby keeping it in your target range. So, it is a versatile lure which can be used for fishing from the surface to the bottom.



20g
GREBE

H:76mm

W:18mm

H:52mm
W:14.5mm

LADIA



No.703 LADIA Lineup: 7g , 10g-52mm ¥600



7g/10g
LADIA

YARIE
CREATIVE FISHING GEAR

SP spoon



Features

- Look for a spot where fish is boiling on the surface and make a long cast with DOVE.
- It has excellent flying distance.
- It works effectively on a slow retrieve.
- It has good kick back actions.

Dove WF



Boat Snatcher

Its steel body with the length of 83mm and the weight of 20g provides excellent flying distance. The thin body with the wide front allows for slow retrieve. It has strong appeal when making a fall, and its excellent kick back actions enable you to reach target fish hiding under overhanging trees.

No.678 DOVE WF Lineup: 20g -83mm ¥950

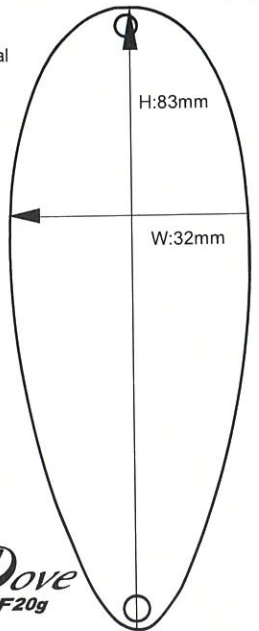
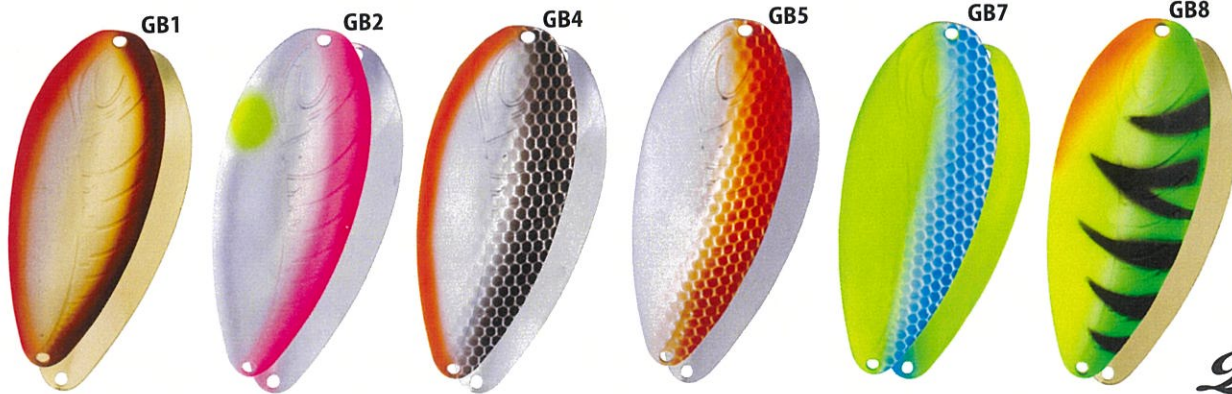

Dove
WF20g

FIRST ORDER



No.711 FIRST ORDER Lineup: 3.6g-32mm ¥500 / 4.5g, 5.4g-34.5mm ¥550



H:32mm
W:12.2mm

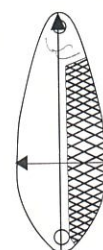

3.6g

H:34.5mm
W:13.2mm

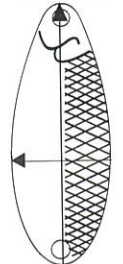

4.5g / 5.4g

No.550 SP-ring

Widely cut ring available for a thick shaft single hook and a hook with a pressed flat shank. A necessary item for deep jigging and jerking.

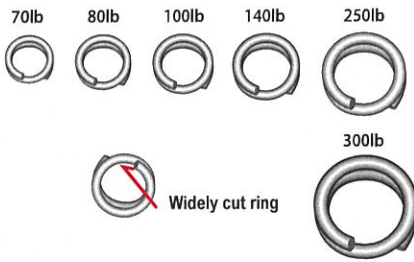

Recommended by Mr. Norihiro Sato

Silver ¥500

No.552 Crosslock snap

The simple shape snap to minimize influence on lure's movement. Shortens the length of the snap as much as possible by making the shape of a tip closer to round. Provides a range of sizes of snaps suitable for sea bass fishing as well as light jigging by using thicker stainless wire than conventional ones to increase the strength.

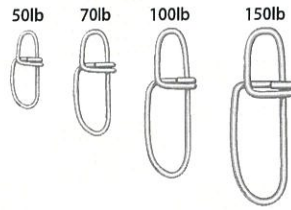

Silver ¥300

No.558 EZ line snap

It is specially designed to be a well-balanced ideal snap with optimal wire diameter, entire length and strength. High-quality snap which enables speedy replacement of lures. Special chip-proof black coating is used.

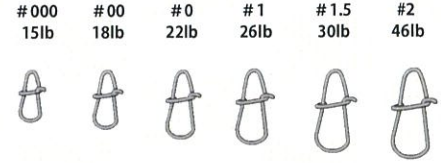

SIZE	Max LB	wire (mm) diameter	total (mm) length	self weight (g)
#000	15	0.35	7	0.017
#00	18	0.4	8	0.024
#0	22	0.45	9	0.036
#1	26	0.5	10	0.048
#1.5	30	0.55	11	0.063
#2	46	0.6	12	0.082

Black ¥200

No.553 Rolling swivel with Crosslock snap

The snap in conjunction with a rolling swivel is lightweight and compact in design. It doesn't prevent the lure swimming, while keeping stable strength and being excellent at rotating.

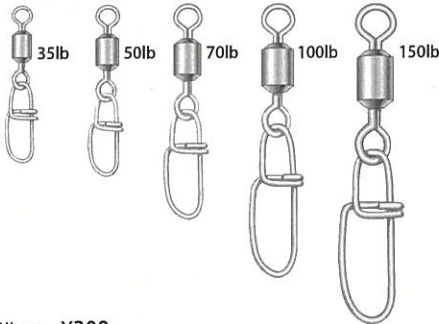

Silver ¥300

No.554 Bearing swivel with Crosslock snap

The snap in combination with a bearing swivel provides excellent rotating performance. As it is a welding ring, you can use it safely when attaching an assist hook to it.

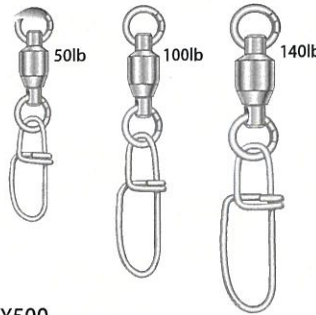

Silver ¥500

No.524 Rolling swivel with EZ line snap

The snap in conjunction with a rolling swivel. It is specially designed to be a well-balanced ideal snap with optimal wire diameter, entire length and strength. High-quality snap which enables speedy replacement of lures. Special chip-proof black coating is used.

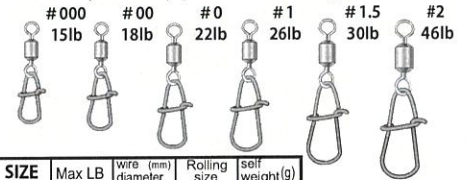

SIZE	Max LB	wire (mm) diameter	Rolling size	self weight (g)
#000	15	0.35	#18	0.017
#00	18	0.4	#18	0.024
#0	22	0.45	#16	0.036
#1	26	0.5	#16	0.048
#1.5	30	0.55	#14	0.063
#2	46	0.6	#12	0.082

Black ¥300

No.544 Jig swivel with Split ring

Bearing swivel with split ring and welding ring. The swivel for an assist hook which maximizes rotation of the bearing swivel. High performance in light jigging.

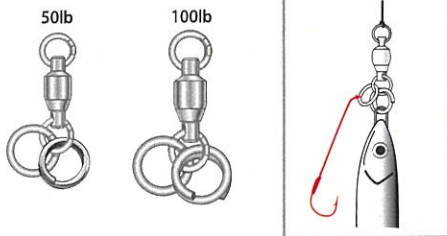

Silver ¥400

No.545 Jig swivel with Crosslock snap

Bearing swivel with cross lock snap and welding ring. High performance in light jigging.

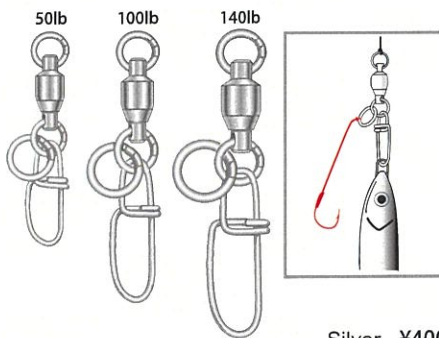

Silver ¥400

No.555 Micro EZ line snap

Based on the EZ Line Snap, we have added SSS and SS sizes to the lineup for small spoons used in area trout fishing. Made with an ultra-thin 0.3mm wire, it preserves the lure natural movement. This snap is designed for compact and lightweight performance rather than strength. Special chip-proof black coating is used.

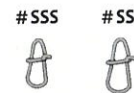

SIZE	Max LB	wire (mm) diameter	total (mm) length	self weight (g)
#SSS	13LB	0.3mm	6.0mm	0.011g
#SS	12LB	0.3mm	6.9mm	0.012g

ブラック
8pec ¥200
24pec ¥500

No.546 System ring

They are system parts suitable for full-fledged vertical jigging. The tying knot to connect a main line to leader line is the weakest link in the line system. It is a welding ring using thick round wire to prevent the knot from breaking.

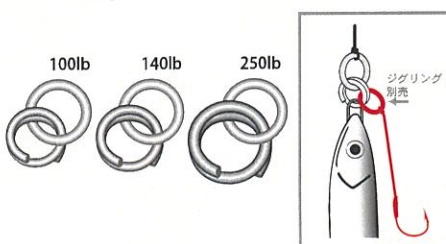

Silver ¥300

No.548 System ring 2

They are system parts suitable for full-fledged vertical jigging. The welding rings use thick round wire to prevent the tying knot which connects a main line to leader line from breaking. Two welding rings help to reduce line trouble.

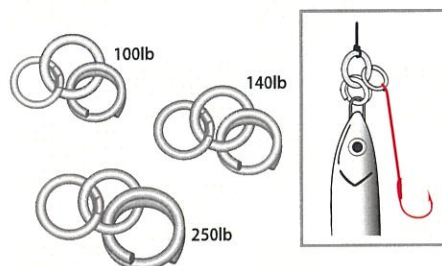

Silver ¥350

No.549 System swivel

Rolling swivel with stainless steel rings in combination with SP ring to ensure strong connection. It can be used as the swivel to be attached to an assist hook for jigging and as the swivel for popper.

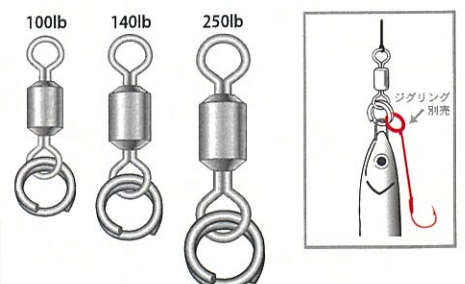

Silver ¥300

No.541 Good snap

This slide-type snap achieves perfect weedless effect and provides smooth opening and closing. Coiling on one side provides stable strength. Special chip-proof black coating is used.

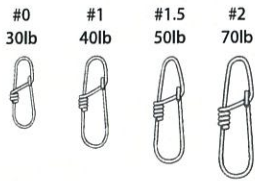

Black ¥300

No.809 Line snap

Lightweight, round and easy-to-use snap. Special chip-proof black coating is used.

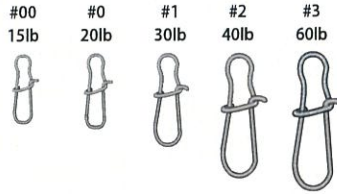

Black ¥200

No.530 Snap ring

You often have to change colors, shapes and weights of lures to look for the best one according to conditions of fishing places. Snap ring is very convenient ring which enables you to quickly change lures.

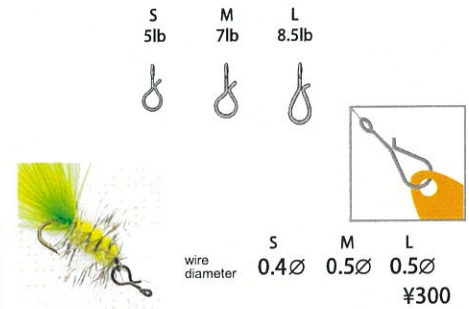

wire diameter
S 0.4Ø M 0.5Ø L 0.5Ø
¥300

No.543 Rolling swivel with Good snap

The snap in conjunction with a rolling swivel. Its compact design and stable strength eliminate line twists. Special chip-proof black coating is used.

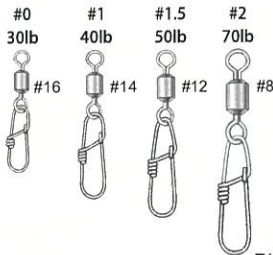

Black ¥300

No.810 Rolling swivel with Line snap

The snap in conjunction with a rolling swivel. Lightweight, round and easy-to-use snap. Special chip-proof black coating is used.

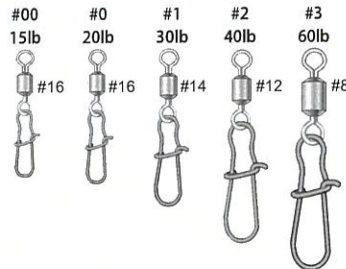

Black ¥300

No.529 Rolling swivel with Snap ring

You often have to change colors, shapes and weights of lures to look for the best one according to conditions of fishing places. Snap ring is very convenient ring which enables you to quickly change lures. The snap in conjunction with a rolling swivel.

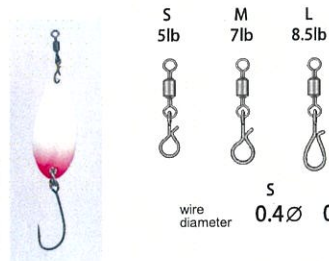

wire diameter
S 0.4Ø M 0.5Ø L 0.5Ø
¥300

No.535 Jig ring (Round shaft welded type)

Arc welding by melting stainless steel provides more stable strength.

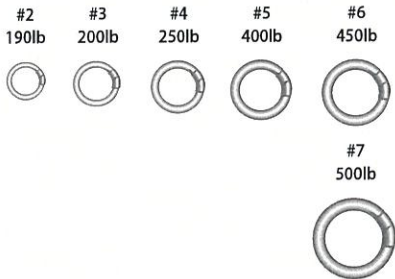

Recommended by Mr. Norihiro Sato

Silver ¥450

No.539 Hachinoji snap

The snap opens on both sides and can be freely combined with any swivel you like. It is a simple round design which will not prevent the lure swimming.

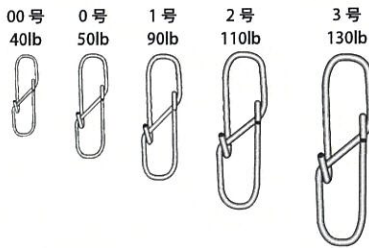

Silver ¥200

No.805 Rolling swivel

This tiny swivel has twice the strength of a brass barrel swivel. Designed to eliminate line twists.

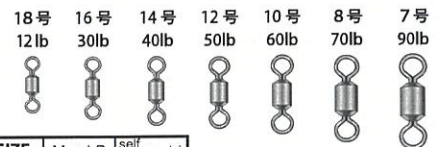

SIZE	Max LB	Self weight (g)
#18	20	0.06
#16	30	0.07
#14	40	0.10
#12	50	0.14
#10	60	0.20
#8	70	0.31
#7	90	0.48

Black ¥200

No.806 Split ring

Flat pressing, carbide stainless steel ring.

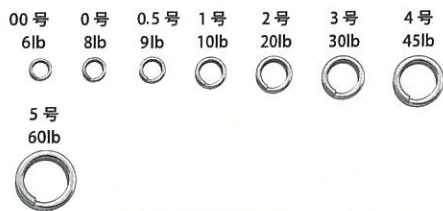

SIZE	Max LB	inner (mm) diameter	self weight (g)
#00	6	2.4	0.016
#0	8	2.7	0.023
#0.5	9	2.9	0.031
#1	10	3.3	0.041
#2	20	3.7	0.065
#3	30	4.5	0.107
#4	45	5.4	0.186
#5	60	5.9	0.305

Silver ¥200
Black ¥250

No.806 Split ring Wax

Split ring with wax coating. It is a flat pressing, carbide stainless steel ring. The split ring is coated with wax, thereby making it easier to pass the ring through a hole of a spoon and preventing damage to the painting of a lure.



Value Pack 100% Wax

SIZE	Max LB	inner (mm) diameter	self weight (g)
#0	8	2.7	0.023
#0.5	9	2.9	0.031
#1	10	3.3	0.041
#2	20	3.7	0.065

Black ¥650

No.557 BF-ring (Big fish ring)

Flat pressing, carbide stainless steel ring. The strength is increased by making the wire diameter larger.



SIZE	Max LB	wire (mm) diameter	inner (mm) diameter	self weight (g)
#1.5	25	0.65	3.2	0.06
#2.5	55	0.75	3.6	0.09
#3.5	65	0.85	4.4	0.14
#4.5	80	1.0	5.2	0.23
#5.5	110	1.2	5.8	0.36
#6.5	120	1.3	6.5	0.48

Silver ¥250

YARIE

TROUT HOOK



NANOTEF is fluorine-based resin coating applied to the surface of hooks.

- Thin coating which contributes to sharpness of hook points and weight reduction.
- Improved water repellency and rust-prevention.
- Reduction of frictional resistance which increases penetration force.



No.727 MK hook Sharp **16 pieces** ¥ 500
size: #9, #8, #7, #6, #4
35 pieces ¥ 1000 size: #9, #8, #7, #6, #4

These hooks are made of high carbon steel based on MK hook 2 with a good design and a long-tapered point, aiming at sharpness and durability of the hook point with special fluorine coating by flat pressing process. They are designed to make a hook point to quickly pierce deeper into a fish's mouth and to hold the fish tight with the bend.

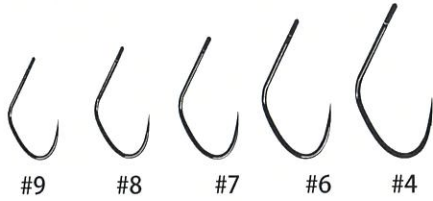

They can be used for all of yarie spoon. **barbless**

No.726 MK hook 2 SSS **15 pieces** ¥ 500
size: #10, #8, #7, #6
50 pieces ¥ 1500 size: #10, #8, #7, #6

These hooks pursue sharpness with a long-tapered point and shhin wire. Thinner coating than conventional ones allows the point to keep its sharpness. Special fluorine coating enables a hook point to stick a fish quickly. Reduction in frictional resistance enhances penetration force of the point drastically.

SLIM SHARP SPEEDY
 #10-0.39mm #8-0.41mm #7-0.43mm #6-0.45mm

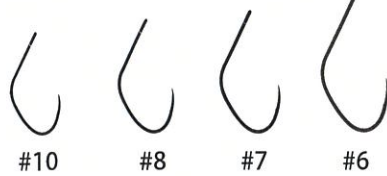

barbless

No.729 MK hook Hyper **16 pieces** ¥ 500
size: #6, #4
35 pieces ¥ 1000 size: #6, #4

These hooks are good design and a long-tapered point aiming at sharpness and durability of the hook point by flat pressing process. They are designed to make a hook point to quickly pierce deeper into a fish's mouth and to hold the fish tight with the bend. These hooks work well when trout activity is high or when aiming at for big trout.



barbless

17

Part number change 731 and 741 are the same.
No.741 ST hook **15 pieces** ¥ 500
size: #10, #9, #8, #7, #6
33 pieces ¥ 1000 size: #10, #9, #8, #7, #6

The points of these hooks are designed to go outward slightly with a wider gap so that even a shallow bite can ensure a deeper penetration of the point. A longer point helps prevent fish from getting away due to the slightly outward points. In addition, a shorter total length of a hook secures hooking when a fish bites a lure directly.

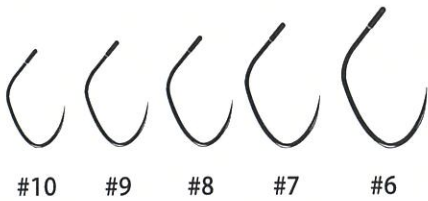

barbless

No.732 ST hook FLAT EYE **15 pieces** ¥ 500
size: #8, #7
for cranks and minnows **33 pieces** ¥ 1000 size: #8, #7

It is a hook with a vertical hook eye for cranks and minnows. We pay much attention to the shape of the hook to ensure good hooking by tilting the hook eye outward slightly to widen the distance between the hook eye and the hook point. A hook point goes outward slightly so that the hook is stuck in fish deeper with even a small bite. Its longer point helps prevent fish from getting away due to the slightly outward points.

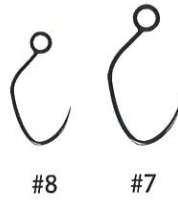

barbless

A vertical eye hook
 The hook point goes outward slightly.



The bottom of the bend holds a fish tight after the hook's point penetrates the fish's mouth.

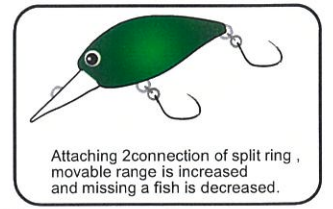

Attaching 2 connection of split ring, movable range is increased and missing a fish is decreased.

No.736 GL hook **16 pieces** ¥ 500
size: #8, #6
35 pieces ¥ 1000 size: #8, #6

By tilting the hook point toward the eye, force will not be dispersed when you get fish on the hook and the hook point will pierce deeper into a fish's mouth. It will significantly prevent escape of hooked fish. The hook is designed to hold any fish firmly by making the throat longer and angling the hook in the middle.



barbless

No.739 MK hook SSS wide **15 pieces** ¥ 500
size: #9, #8
33 pieces ¥ 1000 size: #9, #8

SLIM SHARP SPEEDY
 Introducing the evolved MK Hook SSS Wide, the next level of the Triple S Concept Hook. It is specifically developed to target tough fish under high pressure: fish that don't turn, ultra-slow fish, and those that are hesitant to bite under extreme pressure.

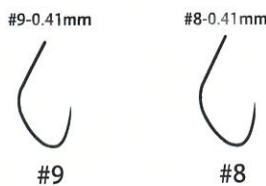

barbless

No.740 KZF hook FLAT EYE **15 pieces** ¥ 500
size: #9, #8
33 pieces ¥ 1000 size: #9, #8

Attach the hook to the side eye of the crankbait using double ring. By using this setup, the hook's range of motion increases, reducing the likelihood of the fish coming off. The hook eye is designed to be smaller and slightly angled outward to ensure a better gap, helping to secure even subtle bites. For minnow lures, please use a single hook on the eye.

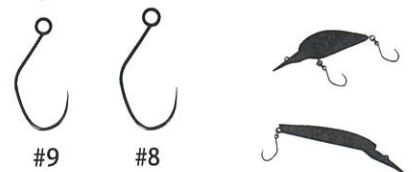

barbless

Representative Lure Shape Hook Compatibility Chart

○••Yes applicable
 △••Applicable depending on size
 ×••Not applicable

	MK2SS	MK3SSW	MKS	MK5TAPER	AG	AG+	FA	ST	GL	PM	STフック	KZフック
Micro spoon	○	○	○	×	○	△	×	×	○	○	×	×
Crankbait	△	△	△	×	○	△	○	○	×	×	○	○
Bottom plug	△	△	△	○	○	△	△	○	△	△	○	○
Floating minnow	×	△	○	×	×	×	△	○	○	○	×	○
Stocking spoon	△	×	○	○	○	○	○	△	△	△	×	×
Targeting large fish	×	×	△	○	×	○	○	○	×	×	○	△

The compatibility chart is an example based on the standard use of typical lures.

No.728 AG hook

16 pieces ¥500
 size: #12, #10, #8, #7, #6, #5
 35 pieces ¥1000 size: #12, #10, #8, #7, #6, #5



These hooks have straight points. Wide gap design is suitable for initial hooking. They are made of high carbon steel with special fluorine coating by flat pressing process which enhances penetration ability of hooks. These hooks are highly recommended to use at the crucial time in fish stocking places and in situations where fish are very inactive. These hooks can deal with gentle biting.

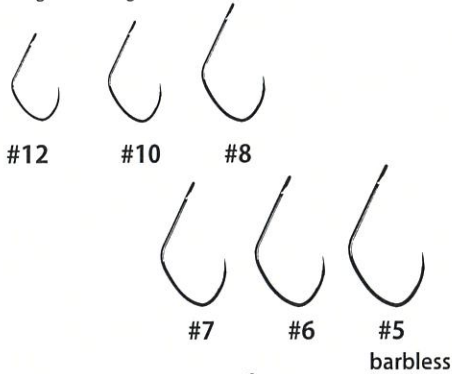

No.734 AG hook plus

16 pieces ¥500
 size: #8, #7, #6
 35 pieces ¥1000 size: #8, #7, #6



AG Hook Plus is the upgrade model of AG hook which demonstrates its remarkable ability for shallow hooking. It inherits the form and concept of AG hook with the wire diameter one notch thicker than that of AG Hook.

It is a versatile hook you can use with less pressure for any fish from difficult-to-catch stocked fish which bite weakly and are hardly hooked to powerful middle-sized trout.

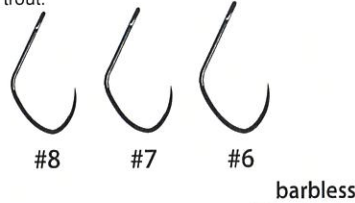

No.733 FA hook



15 pieces ¥500
 size: #9, #8, #6
 33 pieces ¥1000 size: #9, #8, #6

This hook is designed for low-stretch lines. In high-activity conditions, where fish attack the lure from various angles, the hook is designed with a shorter shank to effectively capture bites. Additionally, a thicker gauge is chosen to maintain strength even during strong strikes.

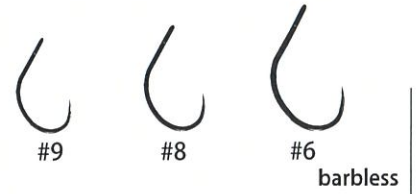

No.733 PM hook



15 pieces ¥500
 size: #8
 33 pieces ¥1000 size: #8

PM hook is a hook to enjoy sight fishing for trout by using surface spoons. This hook can ensure firm hooking, even with a delicate bite of fish on the hook and its hook point which is directed inward also promotes a better bite yield. This hook is also highly appreciated for its better hooking rate in area trout fishing by using minnows. Made of high carbon steel with round shaft specification.

Perfectly suitable for minnows



Native Trout



No.735 Glave hook

12 pieces ¥300
 size: #8, #6, #4



By tilting the hook point toward the eye, force will not be dispersed when you get fish on the hook and the hook point will pierce deeper into a fish's mouth. It will significantly prevent escape of hooked fish. The hook is designed to hold any fish firmly by making the throat longer and angling the hook in the middle.

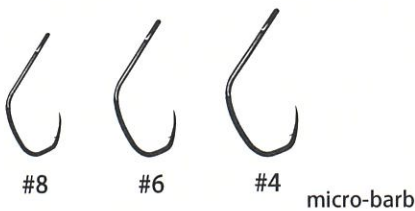

No.720 TROUT hook model1

¥250 color: NS black

Strong semi long tapered point is suitable for use in rough environment like natural river and lake. The semi-barbless hook prevents hooked fish from getting away.

#8: 10 pieces
 #6: 9 pieces
 #4: 8 pieces
 #2: 7 pieces

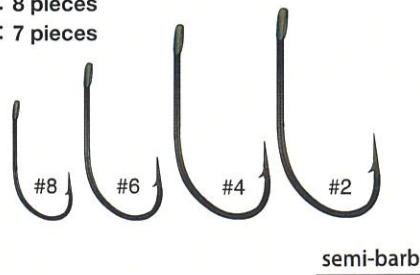

No.738 DIAK hook

12 pieces ¥300
 size: #6
 Super fine wire



The allure of the trout minnow hook is fully embodied in its design. Its sharpness is outstanding, and the holding power ensures that once a fish is hooked, it won't escape—truly remarkable.

Additionally, the presence of a micro barb makes it difficult for fish to shake off, allowing you to securely land them without losing any catches.

To maximize the joy of fishing, give this hook a try.

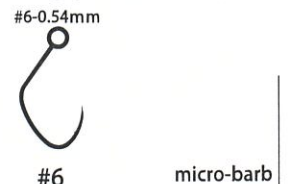

T-Crankup

No.675 T-Crankup

Easy to cast as far as you can
 Appropriate resistance in reeling
 Not likely to be entangled with a hook
 High hooking rate
 Prevent more fish from getting away

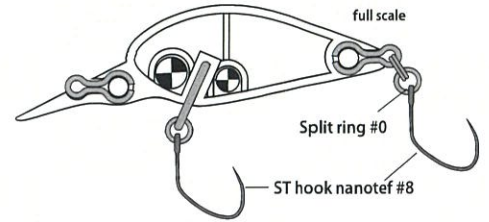

Type F Length: 35 mm
 Weight: 3 g
 Type: Floating
 Price: ¥ 1450

Type LF Length: 35 mm
 Weight: 2.6 g
 Type: Light Floating
 Price: ¥ 1450

Action

When you reel a crankbait at a regular speed, it will produce wobbling action to attract trout strongly. When you reel a crankbait very slowly, it will create rolling action which entice even the ficklest trout to bite.

Lip Form

T-Crankup has a round lip as the round-lipped crankbait does not lose its balance significantly when touching the ground compared to a square-lipped one and it also produces actions which increase the hooking rate.

T-Crankup is suitable to effectively search for fish in medium and bottom layers during the low water temperature season. Adopting a bigger lip to make it sink deeply may increase air pressure, and also cause unbalanced flying position, which may result in short flying distance. T-Crankup is just of similar size to a crankbait developed to capture the middle range, yet it is able to afford an extraordinary flying distance and a sufficient submerging depth.

We recognized from the design stage the necessity of T-Crankup with a long flying distance and strong wave motion which is appropriate for retrieving in shallower range. Through thoroughly repeated tests by changing the material, size and position of a sinker, we finally developed T-Crankup light floating.

Please experience the profound enjoyment of cranking by selecting T-Crankup light floating, T-Crankup or T-Crankup Jr., depending on circumstances.



Eye color
 TypeLF→Clear gray

T-Crankup Jr.

No.675 T-Crankup Jr.

Downsized model with further improved specification

Type SS Length: 28 mm
 Weight: 2.1 g
 Type: Slow Sinking
 Price: ¥ 1430

Type F Length: 28 mm
 Weight: 1.8 g
 Type: Floating
 Price: ¥ 1430

T-Crankup has been highly evaluated by our customers.

Attracting and triggering qualities of the original T-Crankup are adjusted to suit the smaller size of T-Crankup Jr. One of the required performance for a small-size crankbait is a long flying distance. T-Crankup Jr. aims to extend a flying distance not with a heavier sinker, but with a good flight posture by adjusting the weight of a sinker to enable it to sink as slowly as possible. Its quick swimming action helps anglers effectively fish in locations that have not been targeted by previous small-size crankbaits. It is designed to show a strong swimming action for a slow sinking crankbait. This strong action entices active fish closer to the crankbait and stimulate it to bite.

The third product of T-Crankup series is long-awaited T-Crankup Jr. Floating. T-Crankup Jr. Floating enables anyone to search for target fish easily in water layers where sinking models lead to little success, while keeping highly complete potential of T-Crankup Jr. Although its flying distance is a little bit shorter than sinking models, T-Crankup Jr. Floating is a lure with more power to attract fish accordingly and to provoke many bites by enticing fish in the distance. Don't hesitate to try using this floating model when fish are near the water surface and don't bite a lure unless a lure is retrieved slowly.

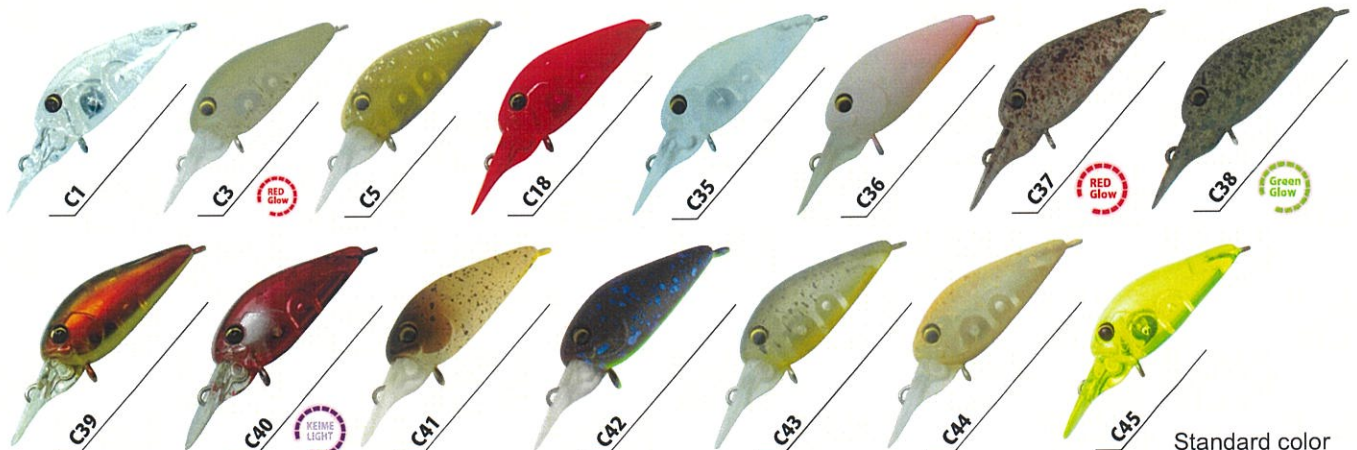
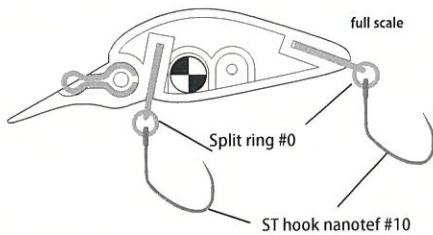

Standard color

No.679

GOAT★

Greatest Of All Time ★

[GOAT STAR]

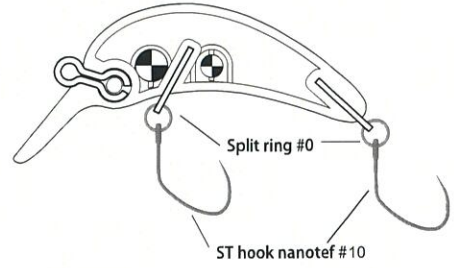

This crankbait was developed to target the range from 15cm to 50cm below the surface. With strong water resistance and a wide wobbling action, it powerfully attracts low-activity trout. Start by retrieving at an ultra-slow to slow speed. It is designed to prevent rolling even at a fast retrieve, allowing for versatile fishing techniques.



20

No.679 GOAT STAR Lineup 2.4 g -35mm ¥1450

Length: 35 mm
Weight: 2.4 g
Type: Floating
Price: ¥ 1450



Recommended spoon for beginners.
Beginners at area trout fishing can use it
without anxiety.

Attractive spoon for everyone

- Appropriate level of pulling resistance allows you to retrieve a spoon easily.
- Micro vibration at hand brings peace of mind that "a spoon is swimming properly."
- It is light enough to be easy to cast.
- It properly moves when you use thick line.
- A range of popular standard colors are offered.
- It responds to a wide-range of retrieve speeds from just after stocking to the situation where fish are inactive.
- It mainly creates wobbling action to attract fish in fast and regular retrieves.
- It mainly creates rolling action to entice fish to bite in slow and very slow retrieves.
- It demonstrates the endless possibilities for intermediate and advanced anglers.
- It produces well-balanced rolling action in vertical jigging situations and is perfect for bottom fishing in the middle of winter.

T-Fresh is produced so that beginner and intermediate anglers can enjoy area trout fishing easily. T-Fresh EVO aims for further increasing catch rate with the same basic concept as T-Fresh. Anglers can freely manipulate T-Fresh EVO on their own terms from a water-churning action, a wobbling action in regular retrieve to a rolling action in slow retrieve. Available in two weights of 1.5g and 2.0g. Please use T-Fresh and T-Fresh EVO properly according to the situation to further increase your catch rate.

It's All-rounder

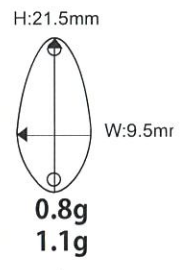
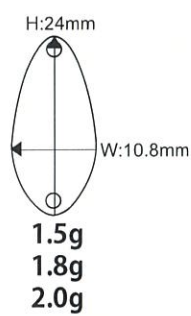
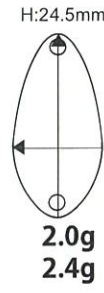

No.708 T-Fresh Lineup: 2.0g, 2.4g ¥500

No.710 T-Fresh EVO Lineup: 0.8g, 1.1g, 1.5g, 1.8g, 2.0g ¥500

COLOR CHART

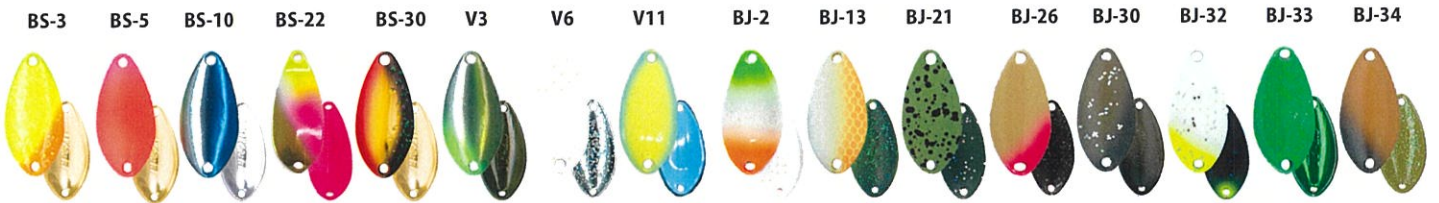

No.709 T-Surface



The shape which is easy to run along the surface layer
 Quiet sound landing on the surface

T-Surface is made to efficiently tackle the surface of the fishing spot which is difficult for conventional surface spoons to approach. It is easier to cast far compared to the similar types of spoons, and is designed to be easy to run along the surface layer. The depth range where T-Surface can display its abilities is from just beneath the surface to 20 cm. Its large silhouette strongly appeals to fish and its rolling action induces fish to bite.

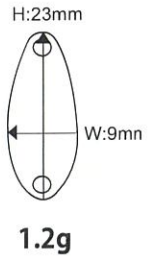

No.709 T-Surface Lineup: 1.2g ¥500

COLOR CHART

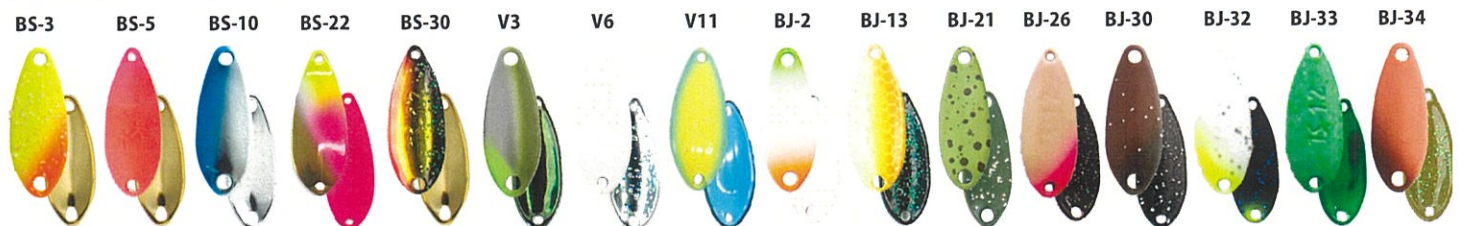



No.707 T-Roll Lineup: 0.6g, 0.8g, 1.0g ¥500

T-ROLL was produced, inspired by movements of nature. It provides two different types of swimming based on bending shapes for different pitches depending on target ranges. Please choose an appropriate one depending on your situation.



0.6g Used for upper surface and surface layers. Provides fine and strenuous pitches.

0.8g Used for surface and medium layers. Provides fine and slow pitches.

1.0g Used for upper medium and medium layers. Provides fine and strong pitches.

Used for medium layer from 20 cm to 1.5 m below the surface. You will relatively increase your catch by the proper use of slow moving T-ROLL 0.8 g in combination with T-ROLL 0.6 g and 1.0 g, depending on situations.

■ COLOR CHART

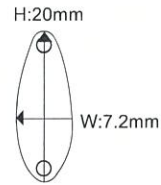

0.6g
0.8g
1.0g

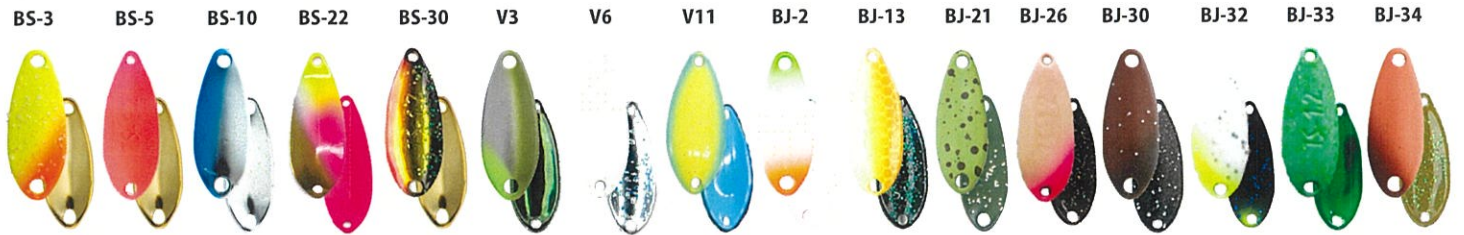

22

No.706 T-spoon Lineup: 0.9g, 1.1g, 1.4g ¥500

T-spoon (1.1 g & 0.9 g) has been developed for handling all water layers in an area with high pressure.

T-spoon (1.4 g) is effective when you want to entice bites from trout by reducing the size of the spoon's silhouette in a situation where trout remain in a deep water layer.



- the automatic slide action
- high range keeping performance
- quick swim start
- kick back action



- regular actions
- high range keeping performance
- quick swim start
- steady swimming actions in streams or rivers

■ COLOR CHART

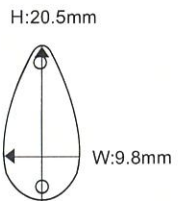

0.9g
1.1g
1.4g

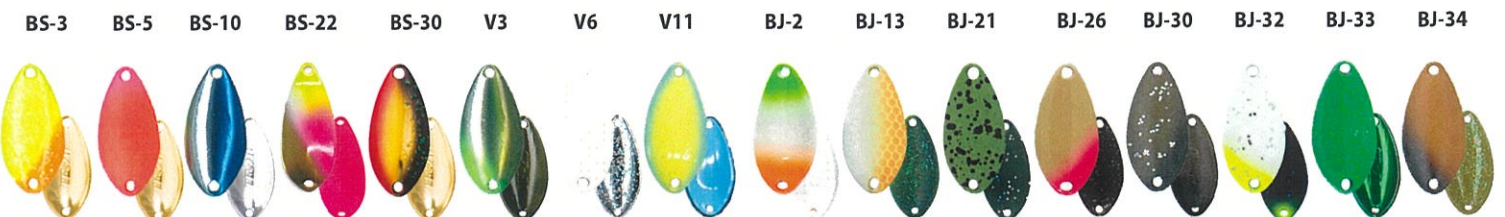

"PIRICA" is a small, lightweight spoon which works effectively on a slow retrieve. As it is designed to provide jiggly and smooth fall and to effectively deal with the flow of water against a spoon, it works well when casting it down or down-cross in streams or rivers. PIRICA, which is recognized for its stable swim, enables anglers to take control of actions of a lure the way they want so that they can entice a bite at the target moment.

■COLOR CHART Lineup: 0.7g, 1.0g, 1.5g, 1.8g, 2.2g, 2.6g ¥500

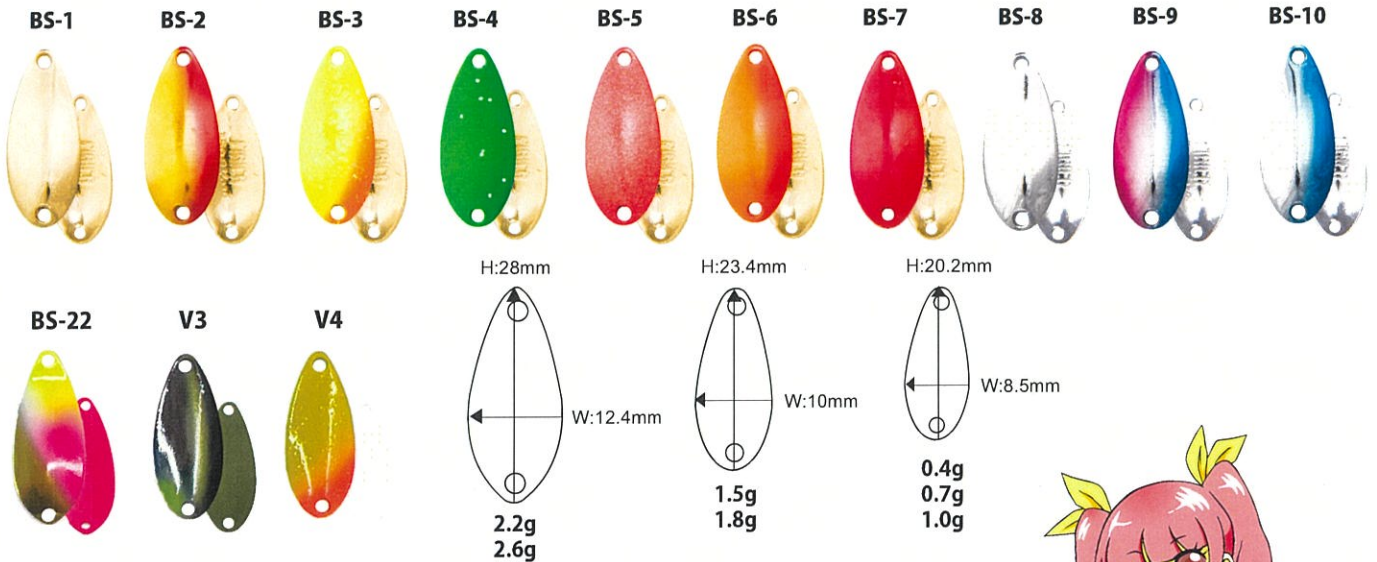

■BS-color Lineup: 0.7g, 1.0g, 1.5g ¥500



23

No.525 Clip Snap 7 piece ¥250

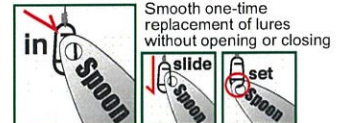

The setting is completed by passing the hook eye of a lure through the gap between wires and shifting it down to the bottom of the wire.

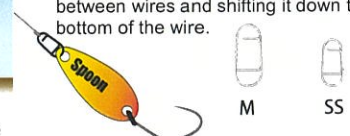

SIZE	Max LB	Max KG	wire (mm) diameter	total (mm) length
M	6.5	3.0	0.5	8.0
SS	3.8	1.7	0.4	6.3

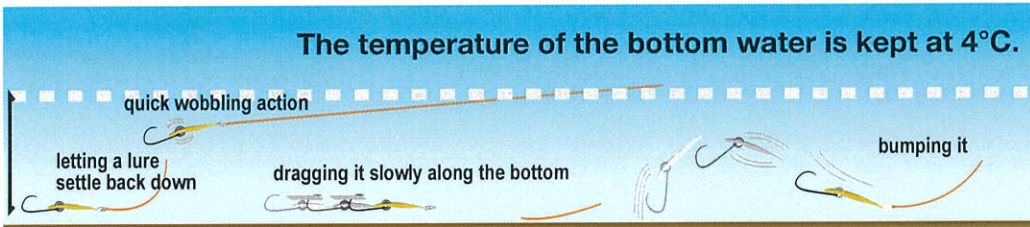

Water is heaviest when its temperature is 4°C. As water is lighter above and below 4°C, the water at the bottom is always be about 4°C, even though the water surface is frozen. The bottom layer of water gives the best environment and very comfortable place for fish in an extreme cold area. Lately you often see anglers catch trout at the bottom by using bottom bumping or fast-twitch and pause mode. This is a clear sign that effectiveness of bottom fishing is gradually known by anglers.

No.705 B-Tap ¥500 Lineup: 0.8g, 1.2g

Both sides are colored the same

Spoon B-Tap developed by an intellectually-minded angler, Mr. Yoshimichi Hasegawa enables a hook standing which was the main difficulty to tackle the bottom fishing. Flexibility of a hook is limited to prevent a hook from falling by attaching a split ring to each loop of two hook eyes at a part little inside of the tail of the spoon. As a result, a hook standing is possible in any situation. As the hook is always standing when "letting a lure settle back down," "dragging it slowly along the bottom," and "bumping it" especially for bottom fishing, it drastically increases your catch. B-Tap produces as quick wobbling action as "PIRICA more" to attract trout. A hook exclusively for B-Tap has been released and it has further increased your catch.

B-Tap ■COLOR CHART

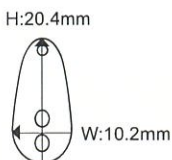

The hook is always standing.

DEXTER



Quick catch of fish

No.712 Dexter Lineup: 2.5g, 3.0g ¥500

They are heavyweight spoons which provide a variety of colors ranging from colors suitable to be used just after stocking, second colors, to third colors. You can directly aim at a offshore spot other anglers overlook by making the most of their heavy weight and tear drop shapes. These spoons are available for going after a wide range of fish from the offshore surface to the bottom as they provide a quick action on start-up for thier weight with wobbling and slightly stronger rolling actions.

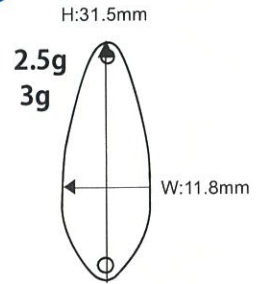

COLOR CHART

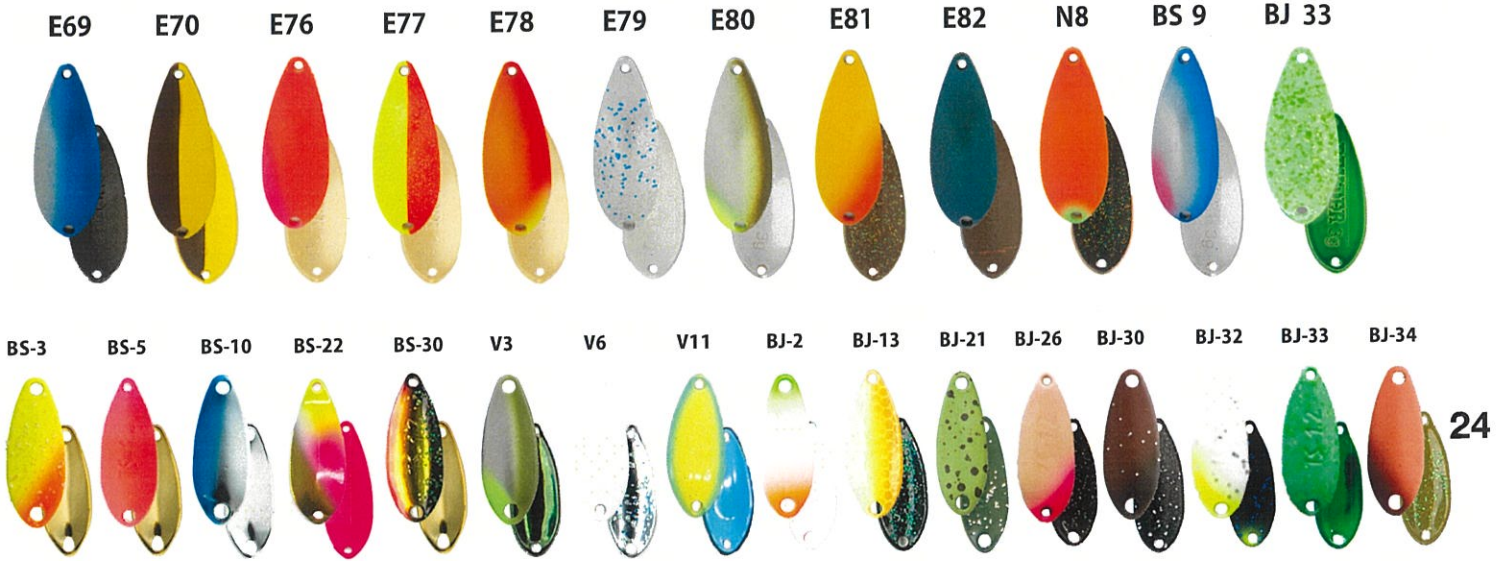

RINGÓ

No.704
Midi

Ringo Lineup: 2.1g, 3.0g

Ringo midi Lineup: 1.3g, 1.5g, 1.8g, 2.0g

RINGO and RINGO midi are designed to reduce a lift by retrieve and provide high range keeping performance. They are highly recommended to use especially in deep ponds with no flow. After casting the lure, please count down at a steady rate and retrieve it, then you can catch one fish after another only by focusing on the place for good fishing and using dead slow retrieve. They enable you to catch more fish snapping at a bait.



COLOR CHART Lineup: 1.3g, 1.5g, 1.8g, 2.0g, 2.1g, 3.0g ¥500

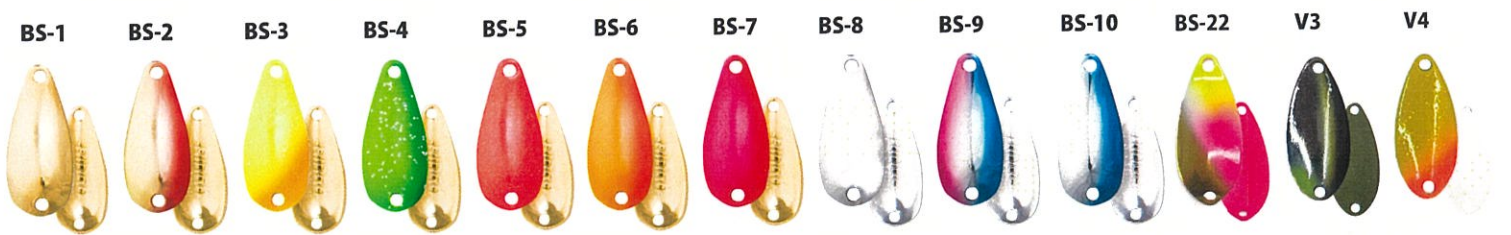

BS-color Lineup: 1.5g, 1.8g, 2.0g ¥500

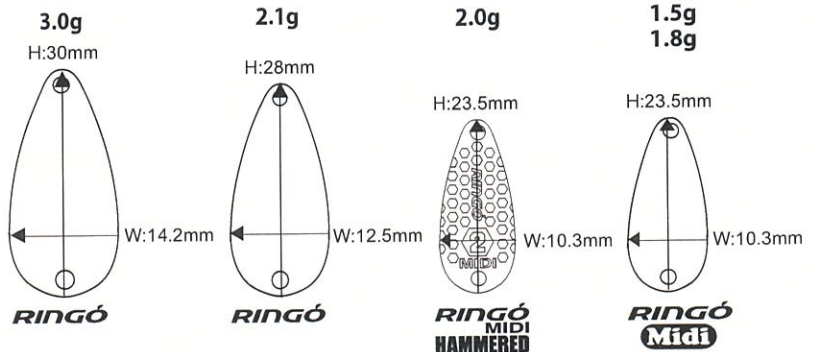

フルーツバスケット

A quick flash of glow pattern on the spoon entices a bite. These spoons work well after stocking until fish becomes inactive. They will surely help increase your catch in muddy ponds and low light conditions.



■Select Fruit-color ¥500 Luminous

- No.702 Pirica more Lineup: 1.0g, 2.2g, 2.6g
- No.704 Ringo midi Lineup: 1.8g
- No.704 Ringo Lineup: 3.0g
- No.706 T-spoon Lineup: 1.1g, 1.4g
- No.707 T-Rool Lineup: 0.8g
- No.708 T-Fresh Lineup: 2.0g, 2.4g
- No.709 T-Surface Lineup: 1.2g



HADEXSHIBU

These colors work well in important situations. They are used as the second color after stocking and for handling tough fishing conditions.

25

HADE



■Hade-color ¥500

- No.702 Pirica more Lineup: 1.0g, 2.6g
- No.704 Ringo midi Lineup: 1.5g, 1.8g, 2.0g
- No.706 T-spoon Lineup: 0.9g, 1.1g
- No.707 T-Rool Lineup: 0.6g, 0.8g, 1.0g
- No.709 T-Surface Lineup: 1.2g
- No.712 Dexter Lineup: 2.5g, 3.0g
- No.710 T-Fresh EVO Lineup: 1.5g, 1.8g

高機動カラー HIGH MOBILITY

These quiet colors lower fish's guard and a quick flash of fluorescent color entices a bite. They will surely help increase your catch!

These colors can be used as the second and third colors a little while after stocking. They also attract the ficklest fish and appeal to fish anytime. They are also helpful to know a fishing situation on the day early in the morning. Diffused reflection of fluorescent color on the dark color background strongly appeals to fish and gives the correct timing to hook fish.



■Select Mobility-color ¥550

- No.702 Pirica more Lineup: 1.0g
- No.706 T-spoon Lineup: 1.1g
- No.707 T-Rool Lineup: 0.8g, 1.0g
- No.710 T-Fresh EVO Lineup: 1.5g

SHIBU



■Shibu-color ¥500

- No.702 Pirica more Lineup: 1.0g
- No.704 Ringo midi Lineup: 1.5g, 1.8g, 2.0g
- No.706 T-spoon Lineup: 0.9g, 1.1g
- No.707 T-Rool Lineup: 0.6g, 0.8g, 1.0g
- No.709 T-Surface Lineup: 1.2g
- No.710 T-Fresh EVO Lineup: 0.8g, 1.1g

Winner-color



These colors help increase your catch with speedy and efficient process of fishing during the time when trout are moving after stocking until trout become inactive.

■ Winner-color ¥500

- No.702 Pirica more Lineup: 1.5g, 2.2g, 2.6g
- No.704 Ringo midi Lineup: 1.8g, 2.0g
- No.704 Ringo Lineup: 3.0g
- No.708 T-Fresh Lineup: 2.0g, 2.4g
- No.710 T-Fresh EVO Lineup: 1.5g, 2.0g
- No.712 Dexter Lineup: 2.5g, 3.0g

Advanced Series

Combination of spoon body and color based on fish activity

Advanced Series: Bright colors



These colors are recommended for use just after stocking, or in second and third stages when fish are very active. They are also appropriate for enticing fish to bite when fishes react to some extent after they calm down a bit. These spoons are a little heavier and bright-colored for tournament use.



■AD Bright color ¥ 500

- No.702 Pirica more Lineup: 2.6g
- No.704 Ringo midi Lineup: 1.8g
- No.704 Ringo Lineup: 3.0g
- No.708 T-Fresh Lineup: 2.4g
- No.710 T-Fresh EVO Lineup: 1.5g, 1.8g, 2.0g
- No.712 Dexter Lineup: 2.5g, 3.0g

Advanced Series: Neutral colors



We have selected colors and weights that can be widely used, from second and third releases to challenging conditions.



■AD Neutral color ¥ 500

- No.702 Pirica more Lineup: 1.0g
- No.704 Ringo midi Lineup: 1.8g
- No.706 T-spoon Lineup: 1.1g
- No.707 T-Roll Lineup: 0.8g, 1.0g
- No.709 T-Surface Lineup: 1.2g
- No.708 T-Fresh Lineup: 2.0g
- No.710 T-Fresh EVO Lineup: 0.8g, 1.1g, 1.5g, 1.8g
- No.712 Dexter Lineup: 2.5g
- No.714 Micro Dexter Lineup: 0.4g, 0.6g

26

Advanced Series: Sober colors



These colors work even when fish does not response well even if you throw any lures. Sober colors such as brownish, olive green and earthy colors are perfect for enticing fish to bite. A new PIRICA more 0.4g will be added to the lineup of the advanced colors series with sober colors.



■AD Sober color ¥ 500

- No.702 Pirica more Lineup: 0.4g, 1.0g
- No.706 T-spoon Lineup: 1.1g
- No.707 T-Roll Lineup: 0.8g, 1.0g
- No.709 T-Surface Lineup: 1.2g
- No.710 T-Fresh EVO Lineup: 0.8g, 1.1g
- No.714 Micro DEXTER: 0.4g, 0.6g

★ Muddy Waters & Dusk

Nagatoro-color



These colors are recommended for twilight and night fishing and muddy waters. Luminescence and matte black HOLOLUME improve the visibility of spoons to attract trout.

■Muddy Waters & Dusk-color ¥ 500

- No.702 Pirica more Lineup: 2.2g, 2.6g
- No.704 Ringo midi Lineup: 1.8g, 2.0g
- No.706 T-spoon Lineup: 1.4g
- No.710 T-Fresh EVO Lineup: 2.0g

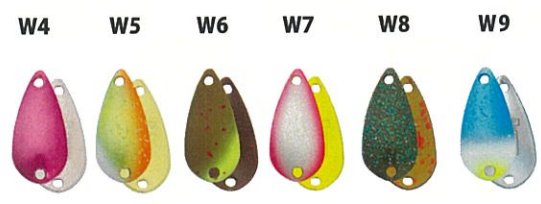

They are suitable for muddy and deep ponds. These fluorescent and luminescent colors attract fish.

■Nagatoro-color ¥ 500

- No.704 Ringo midi Lineup: 1.5g, 1.8g, 2.0g
- No.706 T-spoon Lineup: 0.9g, 1.1g
- No.710 T-Fresh EVO Lineup: 1.5g, 2.0g
- No.712 Dexter Lineup: 2.5g, 3.0g



YARIE's New Micro Spoon Series

The Micro Dexter is a 18mm micro spoon that generates strong water resistance, effectively appealing to the fish's lateral line. With a high-pitch, intense wobbling roll, it maintains a stable movement by minimizing unnecessary sliding. It can handle vertical swimming and tension falls, making it easy for anglers to control with precision. Designed in a teardrop shape, the snap hole has been made as small as possible to reduce water drainage, enhancing water resistance for a stronger presence. Since its action is the complete opposite of the Pirika More, alternating between the two allows anglers to maximize their catch potential.

No.714 Micro DEXTER Lineup 0.4g • 0.6g ¥500

■ COLOR CHART



H:18mm
W:8mm



**0.4g
0.6g**

27

Hologram-color

Much more shining spoon

These colors create more shining and sparkle than plated colors. Hologram makes diffused reflection of light and its color appeals to trout. T-Fresh hologram is recommended to use for stocked fish and active fish, and is also suitable when you are looking for a good spot for fishing in a wide area. Hologram is applied to these spoon lures that are gold-plated or silver-plated.

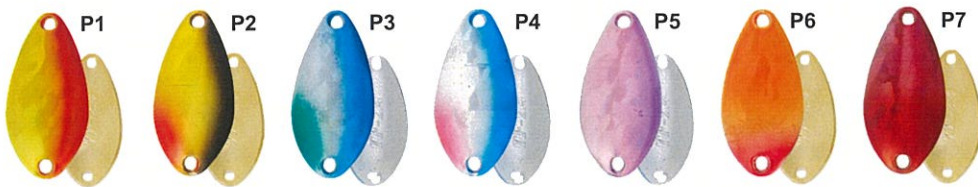

■ Hologram-color ¥600

No.704 Ringo midi Lineup: 1.8g
No.708 T-Fresh Lineup: 2.0g, 2.4

Colors exclusively for export

These colors are exclusively for export. We have chosen spoons of proper size for large and deep ponds with suitable colors for muddy water quality.

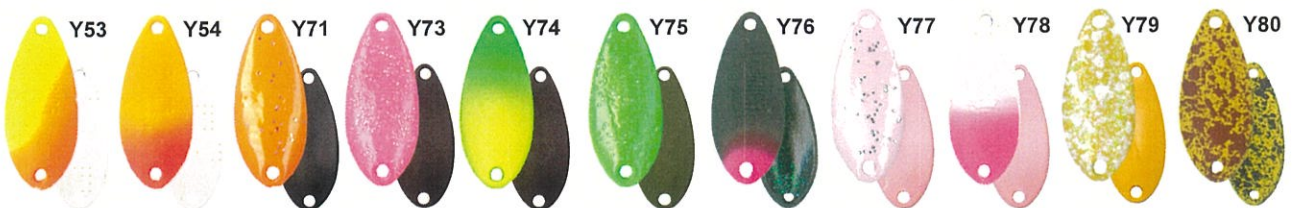

■ Colors exclusively for export ¥500

No.702 Pirica more Lineup: 1.5g, 1.8g, 2.6g
No.704 Ringo midi Lineup: 1.5g, 1.8g
No.704 Ringo Lineup: 3.0g
No.708 T-Fresh Lineup: 2.0g, 2.4g
No.710 T-Fresh EVO Lineup: 1.5g, 2.0g



KEIME ケイムライト LIGHT

Fish species, especially target fish species for lure fishing have better color vision capability than human being. It is said that their visible range includes the ultraviolet light wavelength range in natural light which passes through water. "Keime Light" is special paint which emits fluorescence by responding to ultraviolet light, etc. in water. It appeals to fish more strongly than conventional paint.

It can be applied to all types of lure fishing including area fishing, bass fishing, and salt water fishing. Keime Light has not been used as paint for lures as it is invisible to human eye. Therefore, it is "next-generation paint."

In the case of applying Keime Light to a white spoon

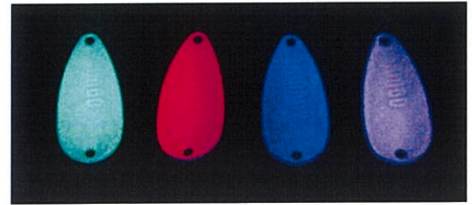

It is observed that Keime Light emits light with a black light in a dark place as shown above, although it is difficult to find that light is emitted in a lighted place.



Mechanism of Keime Light

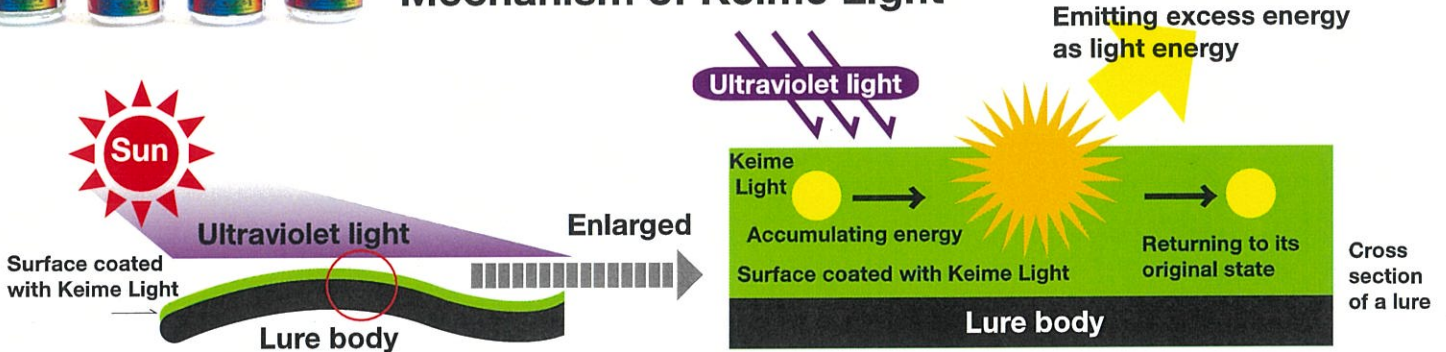

Keime Light continues to emit light eternally as long as it is exposed to ultraviolet light!

How to use Keime Light

A lure whose entire surface is coated with Keime Light works well just after stocking and in muddy water. As Keime Light is paint in ultraviolet light region, responds to ultraviolet light included even in the least amount of light and emits fluorescence, fish always recognize it. It means that if you apply too much Keime Light to a lure, it alarms fish unnecessarily.

Applying Keime Light to a spot on the hook eye side of a spoon



It is a standard way of applying Keime Light to a spoon and it is significantly effective! When fish approach to a spoon enticed by Keime Light and attack it, fish are unlikely to fail to bite it.

Applying Keime Light to the edge of a spoon / the tail of a crankbait



Making flickering effect by applying Keime Light to the edge of a spoon.

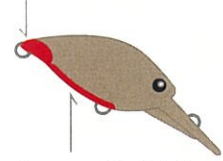

To appeal to fish for a long time

Hololume looks like "hologram" at first glance and glows in the dark.



"Hololume" is the latest lamé paint which unites hologram with luminescent paint. Hololume is new lamé paint which shines like lamé with the unique properties of hologram in a lighted place and glows in a dark place. It shows good luminescent performance and emits green light.

It works well in various situations such as night fishing, muddy waters, bottom in deep waters, a situation where fish are active just after stocking, etc. Hololume is gaining attention as a new material which will be used in various situations in the future.

Hololume

- emits light and gleams in proportion to the strength of light which it is exposed to;
- has a good light resistance and suffers less deterioration;
- enhances attractiveness of the products.



This sticker is attached to products where Hololume is applied.



Under natural light •• Attracting fish with hologram



in the dark
Attracting fish with granular-patterned glow

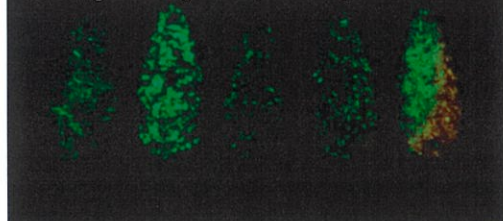

Rivers run through our lives

ACCESS 50

No.677

Minnnows for mountain streams

These minnows have a low center of gravity so they are stable in the water. Even if you down-cast it and reel against the current of the river, it will not jump to the surface. And it is easy to keep the range. The flat body shape and high back of the lure makes it perfect for wobbling and twitching.

Scan the QR code to see an instructional video on ACCESS.



No.677 ACCESS

COLOR CHART



D1



D2



D3



D4



D5



D6



D7



D8

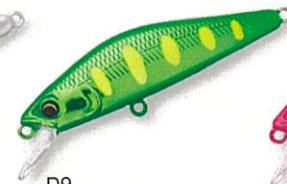

D9



D10

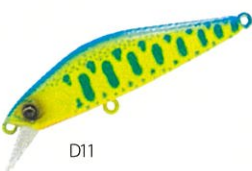

D11



D12



D13

Type S

Length : 50mm
Weight : 3.6 g
Type : Sinking
Price : ¥ 1550

Type HS

Length : 50mm
Weight : 4.3 g
Type : Heavy Sinking
Price : ¥ 1550

BLENDER **Excellent rotation performance makes difference.**

NEW

No.672 Blender Lineup **1.5g, 2.1g, 3.5g, 4.2g**

¥660 ¥660 ¥680 ¥700

- Its quick swimming action enables anyone to search for target fish in a small fishing point.
- Its swivel structure reduces line twists.
- It offers excellent rotation performance even in slow moving water.
- It adopts a specially designed body capable of taking a stabilized swimming position in water.



A new 1.5g size was added to BLENDER lineup.
Glave Hook #8 is attached to the 1.5g BLENDER.

4.2g / 3.5g	2.1g	1.5g
Blade size: M	Blade size: S	Blade size: SS
H:26mm	H:21mm	H:19mm
W:12.3mm	W:10mm	W:9.2mm

FIRST ORDER

No.711 First Order Lineup **3.6g, 4.5g, 5.4g**

¥500 ¥550 ¥550

Their small and thick body enhance their far casting performance. Thanks to their uncompromisingly designed shapes, they easily roll on the bottom of a river and entice fish to bite. They are highly versatile spoons used both for casting upstream in a small mountain stream or casting down-cross stream in the middle part of a river.

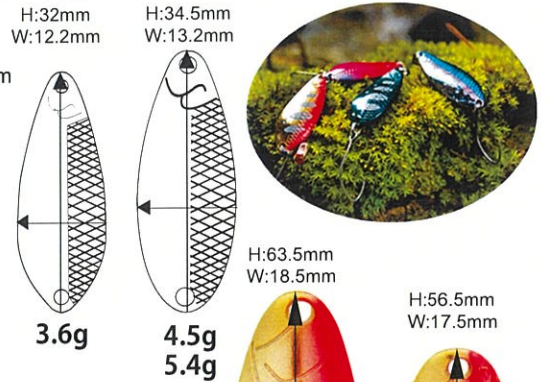
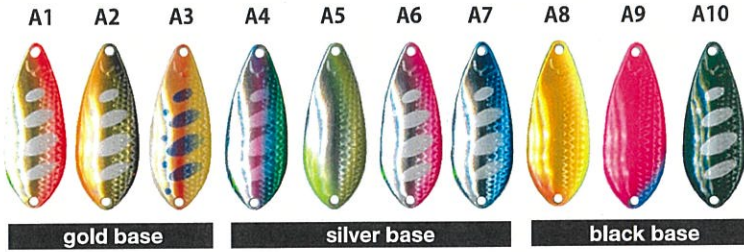

FIRST STAR **No.713 First Star** Lineup **10g, 16g**

¥600 ¥700

Its slim shape and a wide front prevent it from floating and keeps it within the biting range even when exposed to a strong and complex current, which can increase your catch rate.

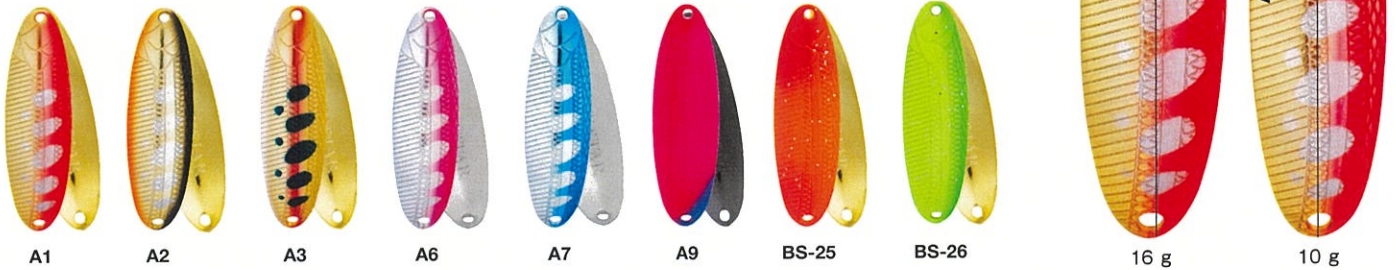

30

PRIMA **No.700 Prima** Lineup **3g, 5g**

¥500 ¥550

"PRIMA" is a willow leaf type spoon and features a sophisticated slender body shape. It moves as if it was dancing in the stream. It makes a quick fall to the targeted range and provides proper rolling and wobbling action and also has turning action just after casting. That is the evidence of its excellent design proven in the field.

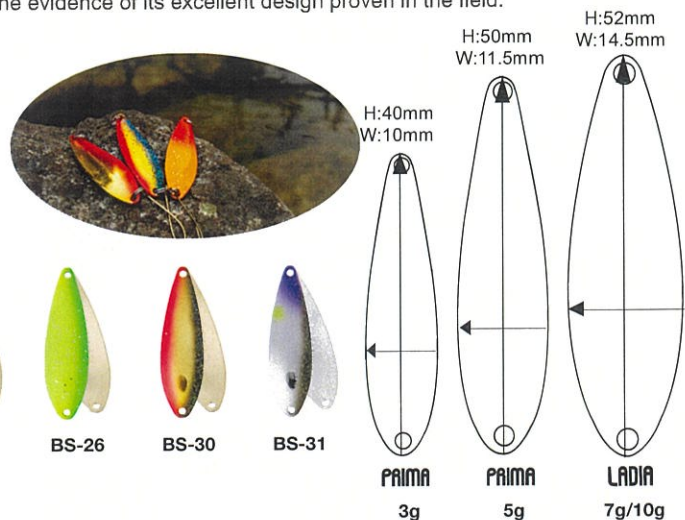

LADIA **No.703 Ladia** Lineup **7g, 10g**

¥600 ¥600

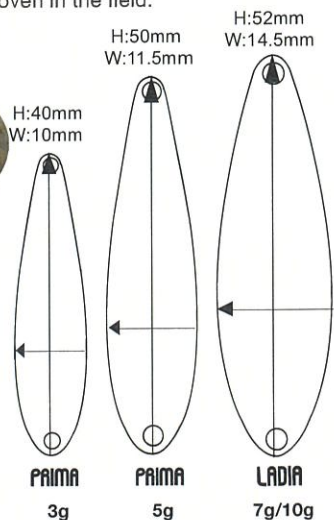

No.771 MIRAI (Stainless metal jig) ¥ 2000



Form and Shine That Captivate the Target.

Total length:67mm W:25mm



110g M1

110g M2

In deep waters where natural light barely reaches, the stainless steel's lasting brilliance continues to reflect even the faintest light, irresistibly drawing in the target.

Despite its basic center-balanced design, the integrated front and rear eyelets, seamlessly molded as part of the body, ensure stable swimming during retrieval while enabling fluttering roll actions and sliding falls during descent—allowing anglers to execute precise movements as intended.

Driven by the idea of reducing the environmental impact of jigs left underwater, we chose stainless steel as the material. By intentionally avoiding nickel and using the more rust-prone SUS400 series, the jig is designed to naturally decompose over time, contributing to a more sustainable future for fishing.

31

No.924 Slim wallet

Color: Black, Green, Blue, Blue camouflage, Olive camouflage ¥ 2000

Size: 85 x 205 x 30 mm

There are six sides · With partition cover · With carabiner



No.911 Line cutter

¥ 500



No.912 Slim Scissors OK PE

9.5cm ¥ 700

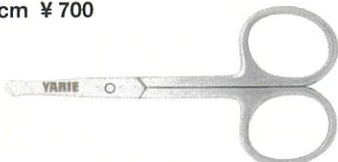

No.801 Split Ring Tweezers

Size: S, M, L ¥ 600

This tweezers-type pair of pliers is lightweight and convenient to carry around. You can attach this pliers to a pin-on reel or a key ring to solve any sudden problems.



No.940 Professional Releaser ¥ 5980

- * The head is designed larger to easily catch the line
- * It allows for a quick release without touching the fish.
- * It can extend and contract from 36 cm to 46 cm in total length.
- * The carbon grip prevents it from feeling cold even in winter.
- * It won't sink even if dropped in a pond.



For barbless hooks
It does not have a function for removing hooks when the fish swallows then
The length can be adjusted using the hex wrench included with the product

No.799 Hold Forceps

14cm ¥ 1650

This pair of hold forceps has no holes for the fingers with an easy-open-close grip. You can open and close this hold forceps with ease even when wearing gloves, so it is useful for fishing in cold winter.





*This feature called "Kokkun" is invented by Yarie. The most important characteristic of the feature is the special shape of its tip. With this special shape, this pair of pliers enables you to keep holding the ring after you take your hands off the pliers.

No.797 Handy Forceps

9.5cm ¥1650
12.5cm ¥1750

This pair of handy forceps, which has a little notch at the tip on one side, enables you to open up a ring, making it useful as a ring opener. Due to its special shape of its tip*, it can also help keep the ring in place even if you put off your hands from the ring and allow you to attach a split ring to a lure easily and smoothly. This pair of handy forceps has the versatile functions of a hook remover, a barb crusher, and a line cutter. This forceps adopts a two-stage locking system, with the first part designed to be locked weakly and the second part designed to be locked strongly.



No.798 Split Ring Pliers JP

14cm Rubberless ¥1650
14cm Charcoal Grip ¥1650

This pair of pliers is designed for extremely small split rings. It also has a feature called "Kokkun", which enables you to open up a split ring and help keep it in place even if you put off your hands from the ring while doing other things. (This pair of split ring pliers is suitable for attaching Size 1 & 2 rings.) This split ring pliers can be used for Size 0 split rings if you attach them in a conventional way. This pair of pliers is recommended in terms of size for light fishing for trout, horse mackerel, rockfish and the like.



No. 913 Split Ring Pliers 2 M

14 cm ¥1300
Black/Orange/Blue

Craftsman-recommended split ring pliers. Due to their versatile nose shape, they are compatible to a wide range of ring sizes and allow you to attach rings to lures easily.



No.800 Split Ring Pliers Multi

14cm ¥1750
16cm ¥1750

This pair of split ring pliers can be used not only as a split ring opener but also for multi-purpose use.

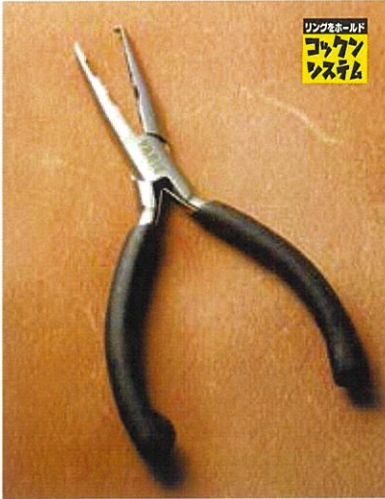

No.802 Split Ring Pliers L

17cm ¥1750

This is a long-nose pliers for jigging. This long tip helps you to keep your fingers a safe distance away from fish's teeth when removing the hook from fish.

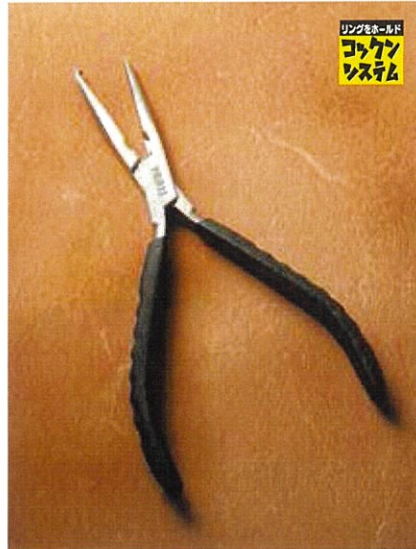

No.914 Best Game Pliers

21.5cm ¥3500

This pair of large pliers is available for sharp-toothed fish such as hairtail and Spanish mackerel and large fish such as tuna and longtooth grouper. It has multiple functions of a hook remover, a split ring opener, and a line cutter.

32

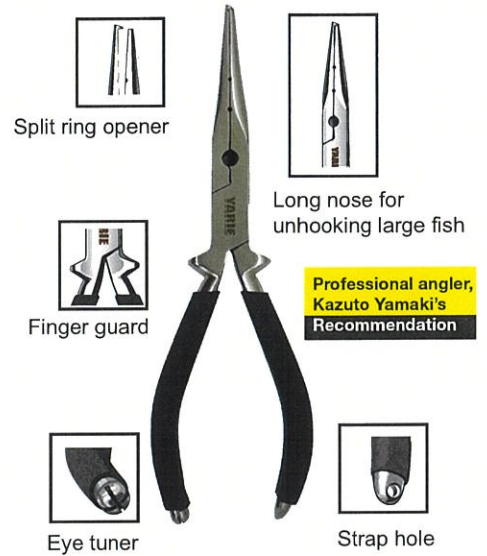

No.804 Forceps (curved)

14cm ¥900 18cm ¥1100 22.5cm ¥1400

This pair of forceps is a hook remover with functions to pinch hooks and lock them. The curved one is larger, designed for big fish such as young Spanish mackerel and hairtail.



Large Rings

No.808 Forceps (curved) with Large Rings

18cm ¥1800

This pair of forceps is handy for easily unhooking fish from large-mouth ones such as bass and red-spotted grouper to small-mouth ones such as scad and trout. It is also suitable for removing squid ink bags.

Features

- The forceps
- adopt a shorter sliding lock to prevent the forceps from being locked when the tips are lightly closed.
- are easily pinned or clipped to your bag or clothes, and
- have large rings that allow you to use them while you wear gloves

*Shorter sliding lock

The lock has been shortened to two ratchet lock since a longer one would get caught during use, thereby making the forceps easier to use.

The lock keeps the blades closed for safe storage.

No.804 Forceps (straight)

14cm ¥900

The straight one is 14 cm long and easy to use. Recommended for fishing in mountain streams and light saltwater.

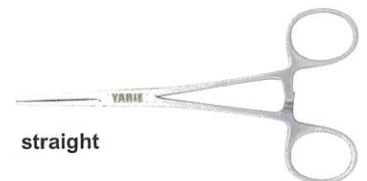

straight

YARIE
Co., Ltd.



YARIE Co., Ltd.

1-34-33, Minamigaoka, Sanda City, HYOGO,
669-1535, Japan
TEL: +81-79-565-0555, FAX: +81-79-565-0556
E-mail: yarie@etanba.co.jp
<https://www.yarie.net/>

The quantity contained in a package may be changed without prior notice.
The product specifications may be changed without prior notice.
The prices may be changed without prior notice.
The colors of the actual products may look different from the colors as
shown on the catalog due to photographing conditions.
The prices do not include consumption tax.

CAUTION!

A hook point is sharp and dangerous. Please handle it carefully.
The products in the catalog should not be used for any other purposes than
fishing.
Keep the products out of the reach of infants and children.
When you cast a lure, check the safety around you and make sure that
there is no danger.